

Die pumpen der baureihen NM, B-NM erfüllen die gültigen EU-Richtlinie 547/2012.

Werkstoffe

Teile-Benennung	NM, NMD	B-NM, B-NMD
Pumpengehäuse	Grauguß	Bronze
Laterne	GJL 200 EN 1561	G-Cu Sn 10 EN 1982
Laufrad	Messing P- Cu Zn 40 Pb 2 UNI 5705	
NM 17	Grauguß	Bronze
	GJL 200 EN 1561	G-Cu Sn 10 EN 1982
Welle	Cr Stahl 1.4104	Cr-Ni-Mo-Stahl 1.4401 AISI 316
	Cr-Ni Stahl 1.4305 von 1,1-1,5-2,2 kW	
Gleitringdichtung	Kohle - Keramik - NBR	

Ausführung

Kreiselpumpen in Blockbauweise; Motor und Pumpe zu einem Blockaggregat verbunden mit gemeinsamer Welle.

NM: einstufig.

NMD: mit zwei gegenläufigen Laufrädern (mit Axialschubausgleich).

Anschlußstutzen: Gewindestutzen DIN-ISO 228/1.

NM, NMD: Ausführung mit Pumpengehäuse und Laterne aus Grauguß.

B-NM, B-NMD: Ausführung mit Pumpengehäuse und Laterne aus Bronze.
(Die Pumpen werden komplett lackiert).

Einsatzgebiete

- Für reine Flüssigkeiten, ohne abrasive Bestandteile, die die Pumpenbaustoffe nicht angreifen (Feststoffanteil bis 0,2% max).
- Zur Wasserversorgung.
- Für Heizungsanlagen Klimaanlage, Kühlkreisläufe.
- Für zivile Einrichtungen und für die Industrie.
- Für Feuerlöschanlagen. - Für Beregnung und Bewässerung.

Einsatzbedingungen

Mediumtemperatur von -10 °C bis +90 °C.

Umgebungstemperatur bis 40 °C.

Vakuummertische Saughöhe bis 7 m.

Höchstzulässiger Pumpenenddruck 10 bar

(16 bar für Pumpen: NMD 25/190; NMD 32/210; NMD 40/180).

Dauerbetrieb.

Motor

2-poliger Induktionsmotor, 50 Hz (n = 2900 1/min).

NM, NMD: dreiphasig (Drehstrom)

230/400 V ± 10% bis 3 kW;

400/690 V ± 10% von 4 bis 9,2 kW;

NMM, NMDM: einphasig (Wechselstrom)

230 V ± 10%, mit Thermo- und Schutzschalter.

Isolationsklasse F. Schutzart IP 54.

Motor geeignet für den Betrieb mit Frequenzumrichter von 1,1 kW.

Effizienzklasse IE3 für Drehstrommotoren ab 0,75 kW.

Ausführung nach EN 60034-1; EN 60034-30-1.

EN 60335-1, EN 60335-2-41.

Sonderausführungen auf Anfrage

- Andere Spannungen. - Frequenz 60 Hz.
- Schutzart IP 55. - Andere Gleitringdichtung.
- Höhere oder niedrigere Mediums- oder Umgebungstemperaturen.
- Motor geeignet für den Betrieb mit Frequenzumrichter bis 0,75 kW.

Kennfeld n ≈ 2900 1/min

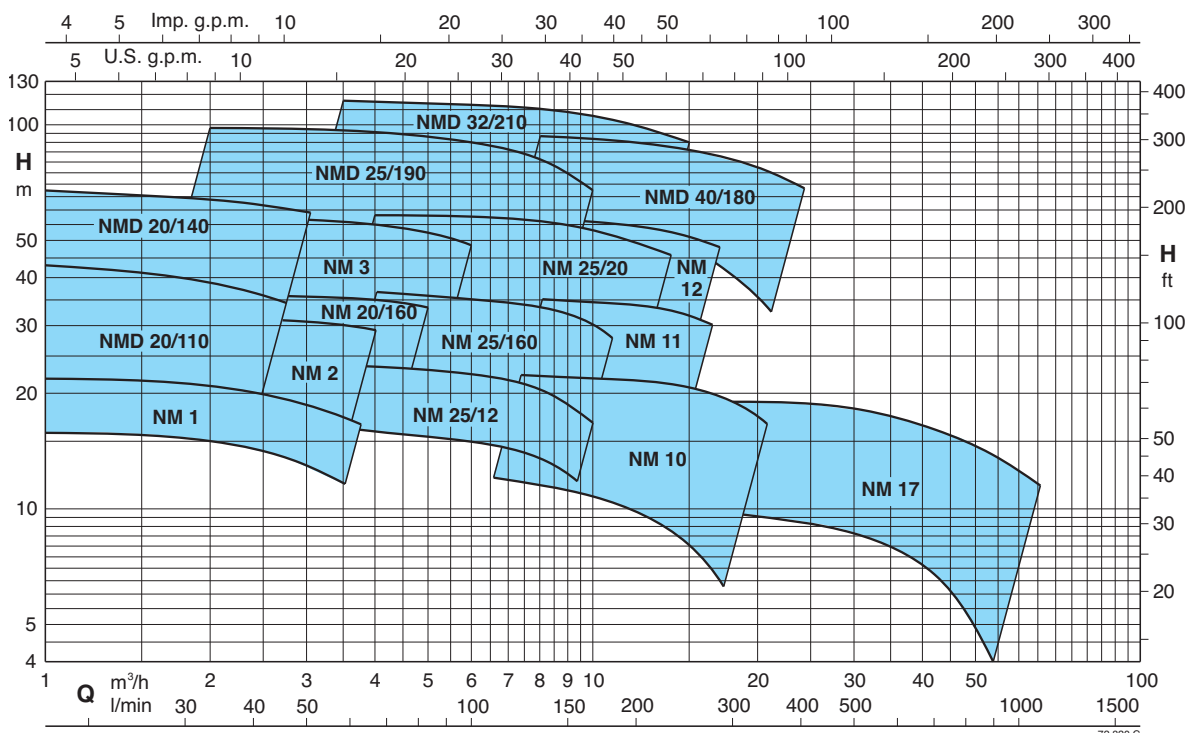

Kenndaten n ≈ 2900 1/min

	NM	P ₂		Q m³/h														
		kW	HP		1 1,2 1,5 1,89 2,4 3 3,6 4,2 4,8 5,4 6 6,6 7,5 8,4													
						l/min	16	20	25	31,5	40	50	60	70	80	90	100	110
	NM 1/AE●	0,37	0,5	H m	22	21,6	21,3	20,9	20,3	19,4	18,1	16,3						
	NM 2/B/A●	0,55	0,75		27	26,5	26	25,5	25	24	23	22	20					
	NM 2/S/A●	0,55	0,75		31	30,5	30	29	27,5	25,5	23,5	20	16					
	NM 2/A/B●	0,75	1		33,5	33	32,5	32	31,5	30,5	29,5	28,5	27	26	24			
	NMM 3/CE	1,1	1,5			37,5	37,5	37	36,5	36	35	34	32					
	NM 3/C/A	1,1	1,5			37,5	37,5	37	36,5	36	35	34	32	30,5	28,5			
	NMM 3/BE	1,5	2			42	42	41,5	41	40,5	40	39	37	35	32			
	NM 3/B/A	1,5	2			47	47	46,5	46	45,5	45	44	43	41,5	40	37,5	33	26
	NMM 3/A/A	1,8	2,5			47,5	47,5	47	46,5	46	45,5	44,5	43,5	42	40,5	38	33,5	26,5
	NM 3/A/B	2,2	3			56	55,5	55,5	55	54,5	53,5	52,5	51,5	50	48	46	42	36

B-NM B-NMD	NM NMD	P ₂		Q m³/h														
		kW	HP		1 1,2 1,5 1,89 2,4 3 3,6 4,2 4,8 5,4 6 6,6 7,5 8,4													
						l/min	16	20	25	31,5	40	50	60	70	80	90	100	110
B-NMD 20/110B/A●	NMD 20/110B/A●	0,45	0,6	H m	33	32	31	29	26,5	23	18							
B-NMD 20/110Z/A●	NMD 20/110Z/A●	0,55	0,75		37	36	35	33	30,5	27,5	23	18						
B-NMD 20/110A/B●	NMD 20/110A/B●	0,75	1		43	42	40,5	39	36,5	33	29	25						
B-NMDM 20/140BE	NMDM 20/140BE	1,1	1,5		52	51,5	51	50	48,5	47	45							
B-NMD 20/140B/A	NMD 20/140B/A	1,1	1,5		53	52,5	52	51	50	48	46	43,5	40					
B-NMDM 20/140AE	NMDM 20/140AE	1,5	2		57,5	57	56,5	55,5	54	51,5	49	46	43	40	36			
B-NMD 20/140A/A	NMD 20/140A/A	1,5	2		67	66,5	66	64,5	63	61,5	59	57	53,5	50	46			
B-NM 20/160BE●	NM 20/160BE●	0,75	1						30,5	30	29,5	28,5	27,5	26,5	25,5	24	22	
B-NM 20/160A/A●	NM 20/160A/A●	1,1	1,5						36	35,5	35	34,5	33,5	32	30,5	29	27	

B-NM B-NMD	NM NMD	P ₂		Q m³/h															
		kW	HP		2,4 3 3,6 4,8 6 6,6 7,5 8,4 9,6 10,8 12 13,2 15 16,8 18														
						l/min	40	50	60	80	100	110	125	140	160	180	200	220	250
B-NM 25/12B/A●	NM 25/12B/A●	0,55	0,75	H m	20	19,9	19,8	19,3	18,5	18	17,3	16,3	15	13,2	11				
B-NM 25/12A/B●	NM 25/12A/B●	0,75	1		23,5	23,4	23,3	22,9	22,1	21,7	20,9	20	18,7	17,1	15,2				
B-NM 25/160B/A●	NM 25/160B/A●	1,1	1,5			31	30,7	30	28,5	28	27	26	23						
B-NM 25/160A/A●	NM 25/160A/A●	1,5	2			36,5	36,2	35,5	34,5	34	33,5	32,5	31	28,5	26				
B-NM 25/200B/C	NM 25/20B/C	2,2	3			42,6	42,3	41,8	41,1	40,7	40,2	39,6	38,6	37,6	36,3	34,7			
B-NM 25/200A/B	NM 25/20A/B	3	4			50,3	50,2	49,8	49,3	49	48,6	48,1	47,3	46,5	45,5	44,3	42,1	38,9	
B-NM 25/200S/C	NM 25/20S/C	4	5,5			57,8	57,7	57,4	57,2	57	56,7	56,4	55,8	55,2	54,3	53,3	51,2	48,2	45,6
B-NMD 25/190C/B	NMD 25/190C/B	2,2	3			62	60,5	59	55,5	51	48,5	44	38						
B-NMD 25/190B/A	NMD 25/190B/A	3	4			76	75	74	70	66	64	60	54	46					
B-NMD 25/190A/B	NMD 25/190A/B	4	5,5			98	97	96	93,5	90	88	84	79	70					

	NM	P ₂		Q m³/h														
		kW	HP		6,6 7,5 8,4 9,6 10,8 12 13,2 15 16,8 18,9 21 24 27 30													
						l/min	110	125	140	160	180	200	220	250	280	315	350	400
	NM 10/FE●	0,55	0,75	H m	12,5	12,5	12	11,5	11	10	9	7,5						
	NM 10/DE●	0,75	1		18	18	17,5	17	16,5	16	15,5	14						
	NM 10/A/A●	1,1	1,5		23	23	22,5	22	21,5	21	20,5	19						
	NM 10/S/A●	1,5	2		23,5	23,5	23	22,5	22	21,5	21	20,5	19	18,5	16,5	13		
	NMM 11/BE	1,5	2		26,5	25,5	25	24	23	22,5	21,5	21,5	19,5	17,5				
	NM 11/B/A	1,5	2		29,5	29,5	29	28,5	27,5	27	26	25*	22,5*					
	NMM 11/A	1,8	2,5		30,2	30,1	29,8	29,4	28,8	28,1	27,4	26	24,5					
	NM 11/A/B	2,2	3		35,5	35,5	35	34,5	34	33,5	33	32*	30*					
	NM 12/D/B	2,2	3		38	37,5	37	36	35	33,5	32							
	NM 12/C/A	3	4		45	44,5	44	43,5	42,5	41	40	38	36					
	NM 12/A/B	4	5,5		57,5	57	56	55,5	55	54,5	53,5	51,5	49					

Kenndaten n ≈ 2900 1/min

1

B-NMD	NMD	P ₂		Q m³/h l/min	5,4	6	6,6	7,5	8,4	9,6	10,8	12	13,2	15	16,8	18,9	21	24		
		kW	HP		H m															
B-NMD 32/210D/B	NMD 32/210D/B	4	5,5	H m	71	69	67,5	65	62,5	58	53	46	37*							
B-NMD 32/210C/A	NMD 32/210C/A	5,5	7,5		84	83	82	81	79	76	73	69	64*	54*						
B-NMD 32/210B/A	NMD 32/210B/A	7,5	10		104	103	102	100	98	95	92	88	84*	76*						
B-NMD 32/210A/B	NMD 32/210A/B	9,2	12,5		114	113	112	110	108	105	103	99	96*	90*						
B-NMD 40/180D/B	NMD 40/180D/B	4	5,5					60	59,5	57	56	53	51,5	48	44	39	34*	25*		
B-NMD 40/180C/A	NMD 40/180C/A	5,5	7,5					69	68	67	66	64,5	63	60	57	53	48*	40*		
B-NMD 40/180B/A	NMD 40/180B/A	7,5	10					87	86	85	84	82,5	81	78	75	71	66*	59*		
B-NMD 40/180A/B	NMD 40/180A/B	9,2	12,5					94	93	92	91	89,5	88	85	82	78	74*	67*		

B-NM	NM	P ₂		Q m³/h l/min	21	24	27	30	33	37,8	42	48	54	60	66	75	84	96		
		kW	HP		H m															
B-NM 17/H/A●	NM 17/H/A●	1,1	1,5	H m	9,5	9,2	9	8,6	8,2	7,5	6,7	5,5	3,5*							
B-NM 17/G/A●	NM 17/G/A●	1,5	2		12	11,7	11,5	11,2	11	10,3	9,7	8,5	7*	4*						
B-NM 17/F/B	NM 17/F/B	2,2	3			16	16	15,5	15	14,5	14	13	11,5*	10*	8*					
B-NM 17/D/A	NM 17/D/A	3	4					18	18	17,5	17	16,5	15,5	14*	13*	11,5*				

NM, NMD Standardausführung.
B-NM, B-NMD Bronze-Ausführung.

P₂ Motornennleistung.
H Gesamtförderhöhe in m.

● Mit einphasigem Motor = NMM - NMDM.
* Maximale vakuummetrische Saughöhe 1-2 m.
Toleranzen nach UNI EN ISO 9906:2012.

Nennströme

	P ₁			P ₂		230 V 1~ IN A	IA/IN
	kW	kW	HP	kW	HP		
	0,62	0,37	0,5			3	2,7
	0,72	0,45	0,6			3,6	2,9
	1	0,55	0,75			4,5	2,3
* NMM 25/12B/A	0,9	0,55	0,75			4,2	2,5
* NMM 10/FE	0,9	0,55	0,75			4,2	2,5
	1,3	0,75	1			6	3
* NMM 25/12A/A	1,2	0,75	1			5,4	3,3
* NMm 10/DE	1,2	0,75	1			5,8	2,6
	1,6	1,1	1,5			7,4	3
	2	1,5	2			9,2	3,8
	2,5	1,8	2,5			11,2	4,5

	P ₂		230 V Δ / 400 V Y 400 V Δ / 690 V Y			IA/IN
	kW	HP	IN A	IN A	IN A	
	0,37	0,5	2,3	1,3		3,8
	0,45	0,6	2,3	1,3		3,5
	0,55	0,75	3	1,7		3,6
* NM 25/12B/A	0,55	0,75	2,8	1,6		3,9
* NM 10/FE	0,55	0,75	4	2,3		4,8
	0,75	1	3,7	2,2		4
* NM 25/12A/B	0,75	1	3,5	2		4,3
* NM 10/DE	0,75	1	4	2,3		4,8
	1,1	1,5	4,6	2,7		5,6
	1,5	2	7,5	4,3		5,5
	2,2	3	9,15	5,3		7,4
	3	4	11,5	6,6		8,2
	4	5,5		9,6	5,5	7,6
	5,5	7,5		10,9	6,3	9,1
	7,5	10		14,3	8,3	9,1
	9,2	12,5		18,5	10,7	8,2

P₁ Max. Leistungsaufnahme.
P₂ Motornennleistung.
IA/IN Anlaufstrom / Nennstrom

Kennlinien $n \approx 2900$ 1/min

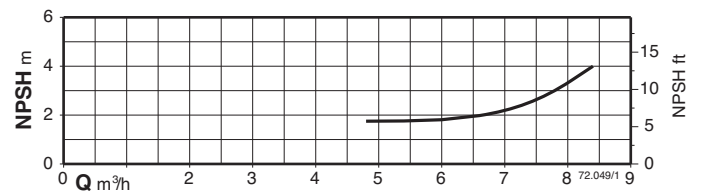
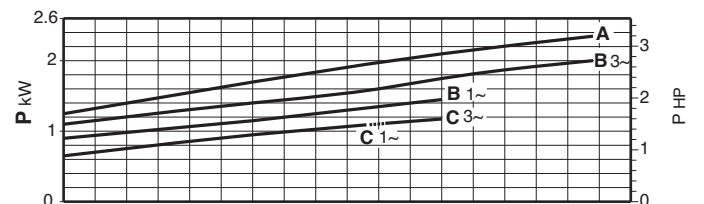
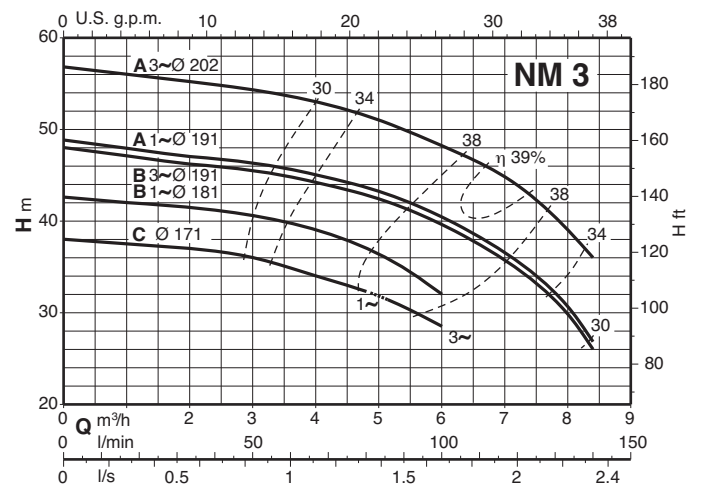
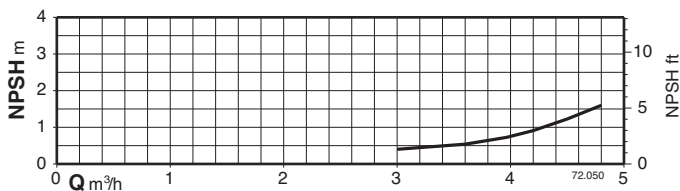
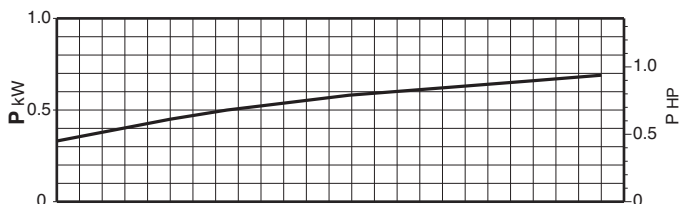
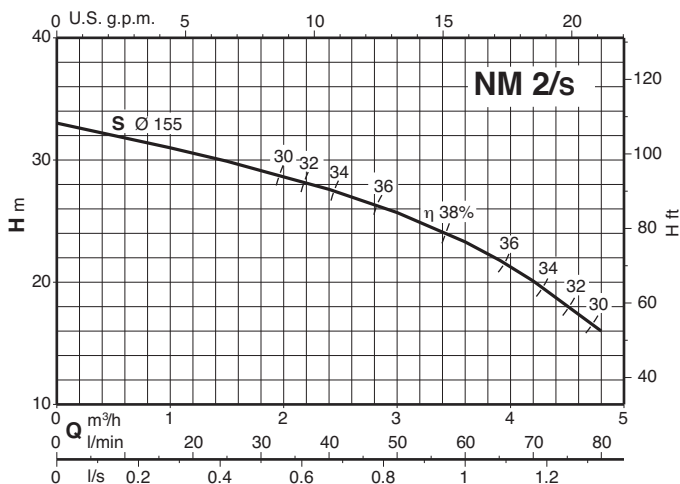
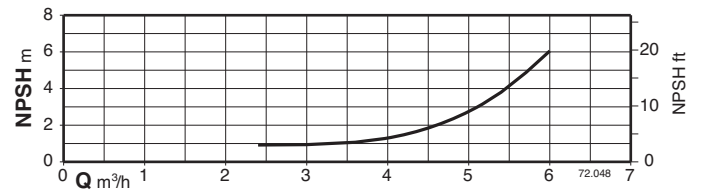
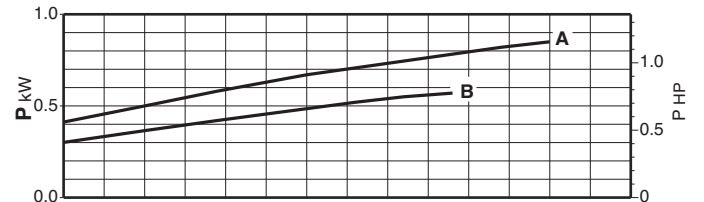
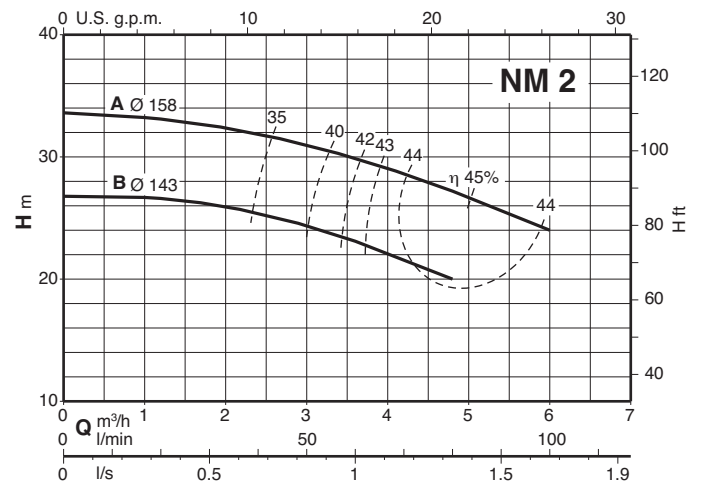
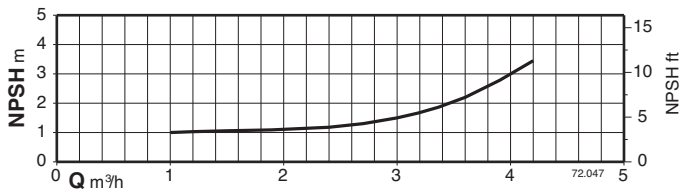
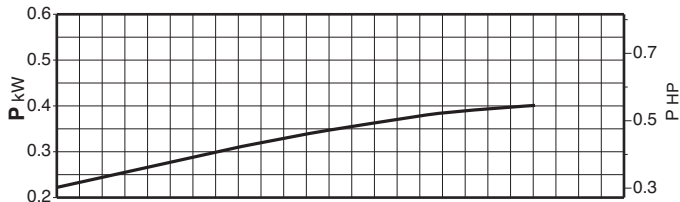
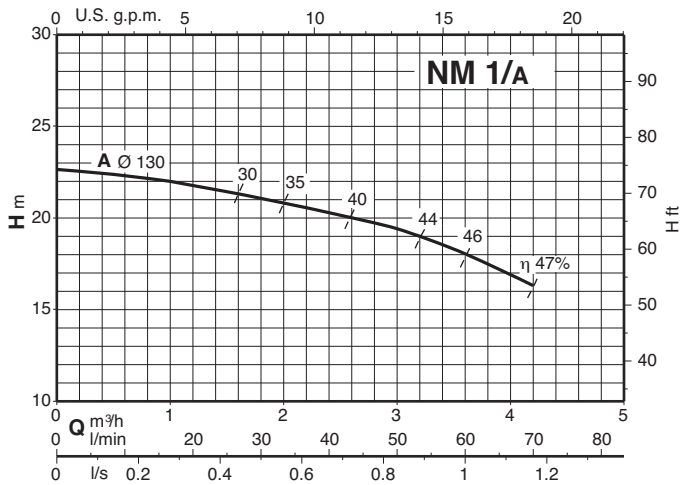

Kennlinien $n \approx 2900$ 1/min

1

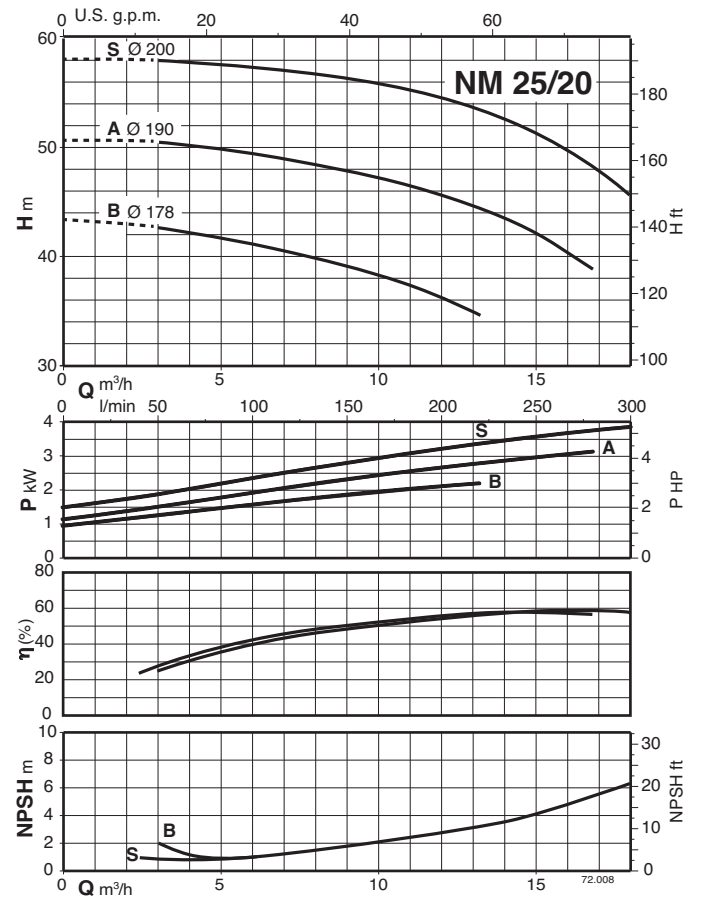
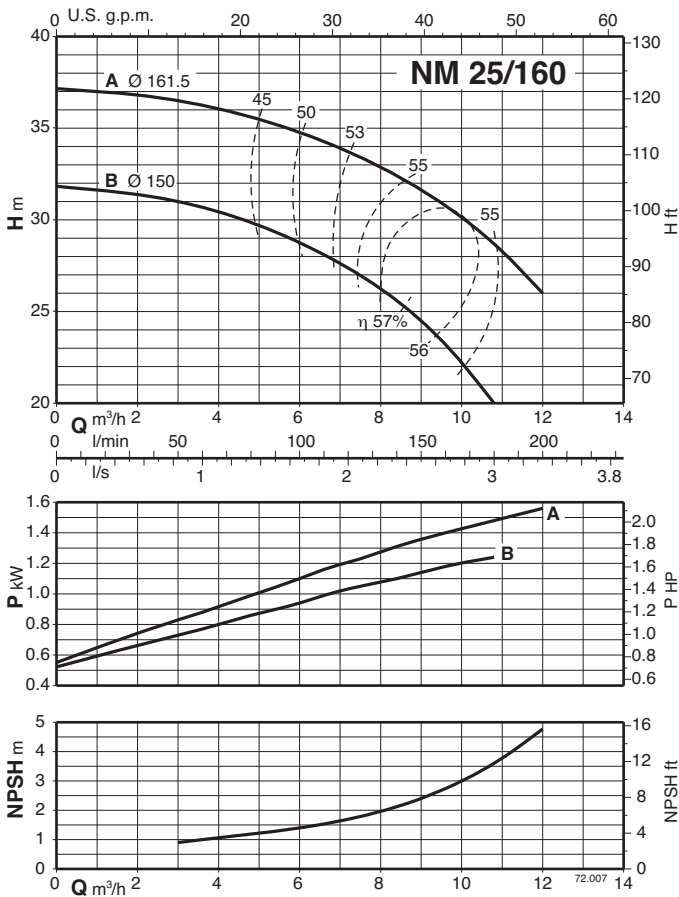
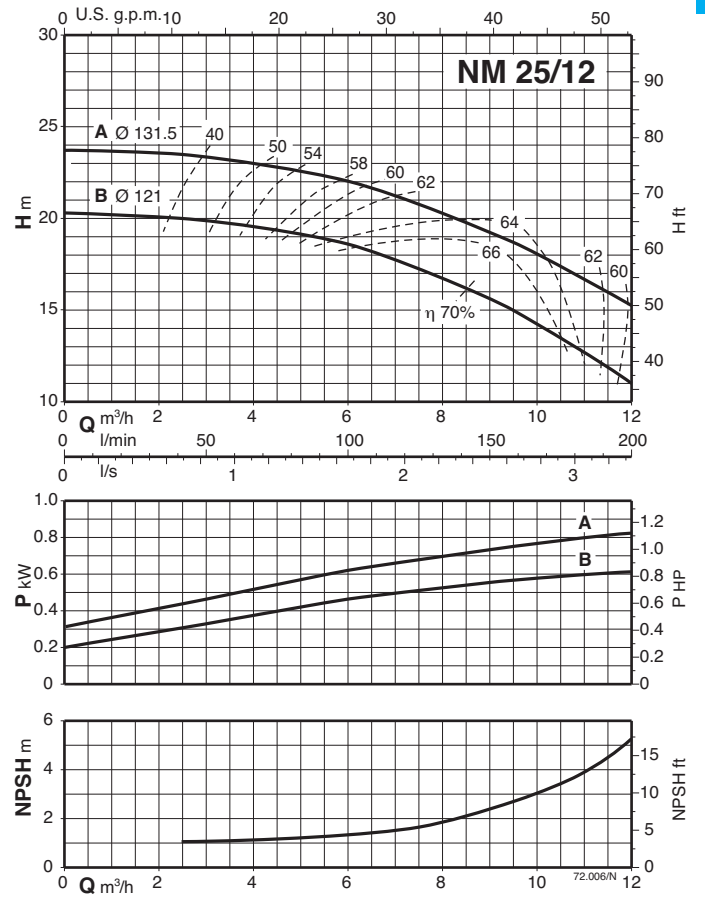
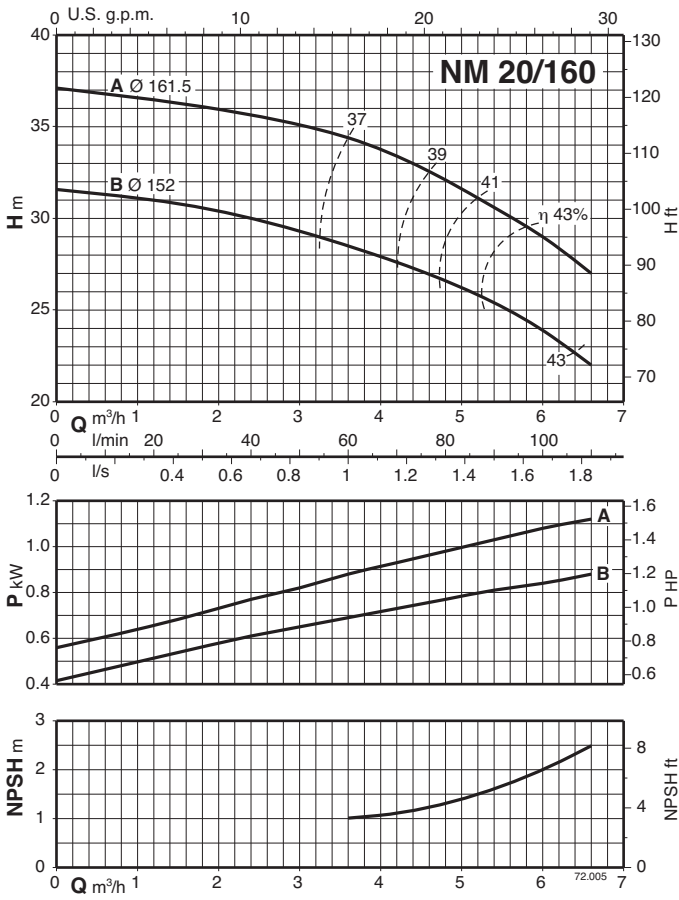

Kennlinien $n \approx 2900$ 1/min

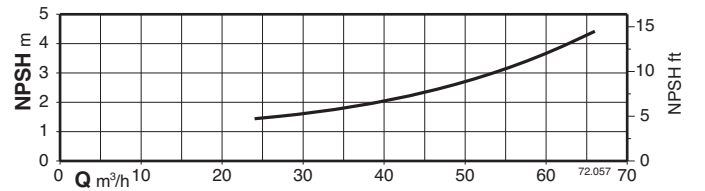
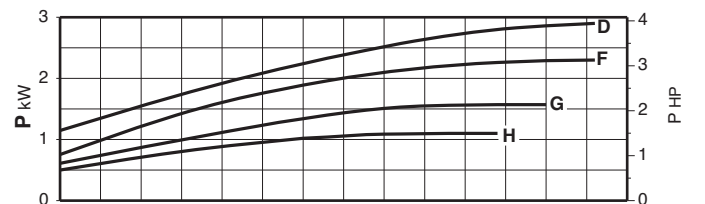
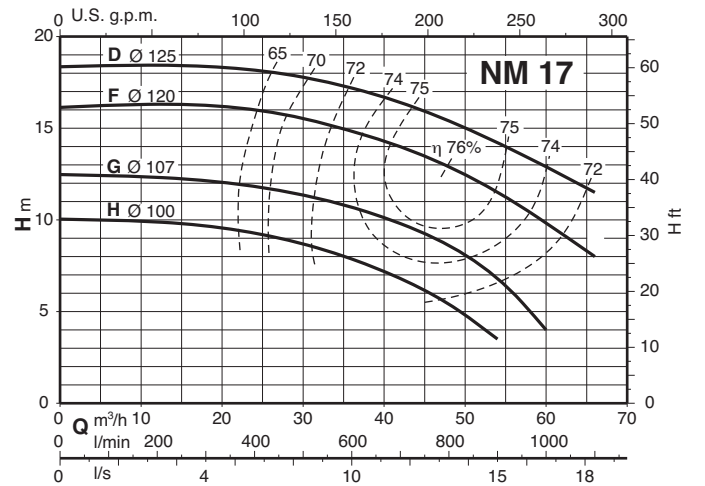
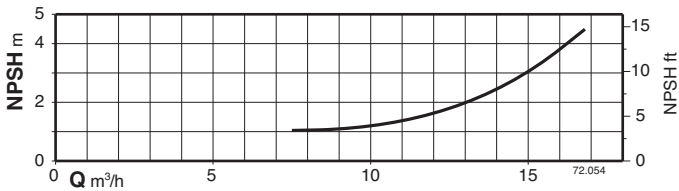
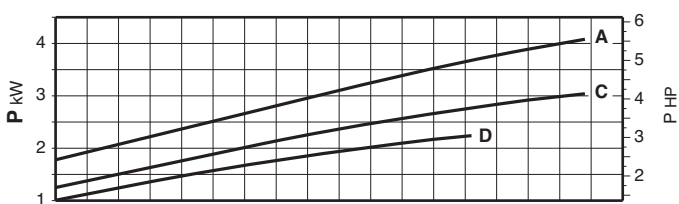
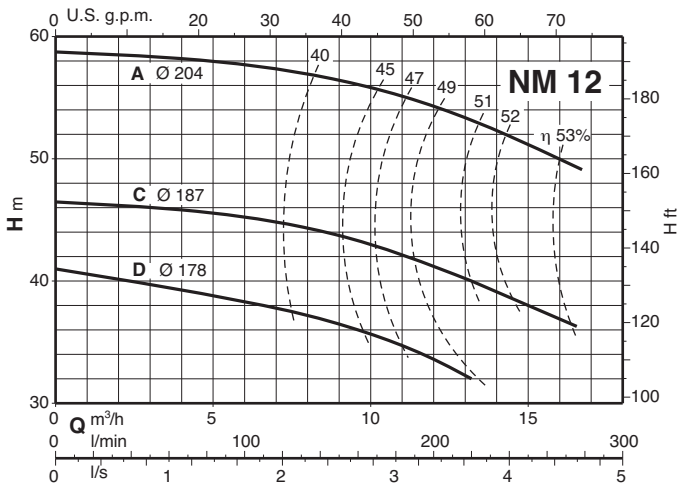
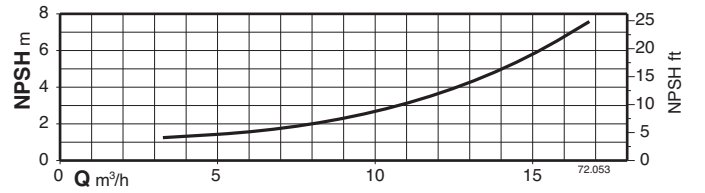
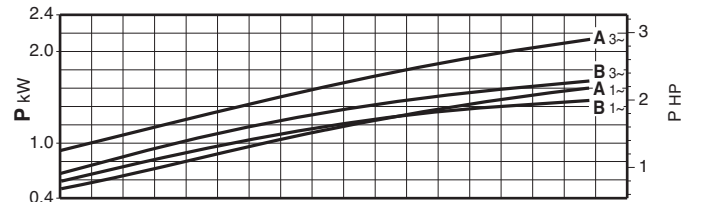
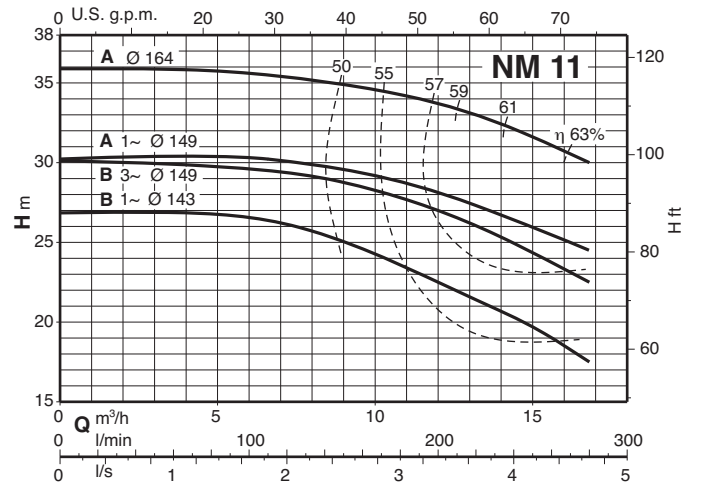
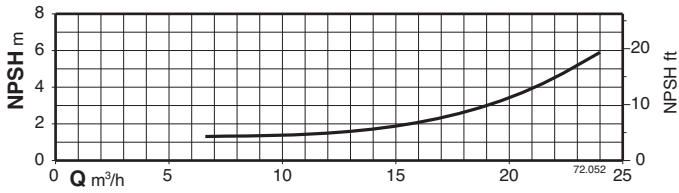
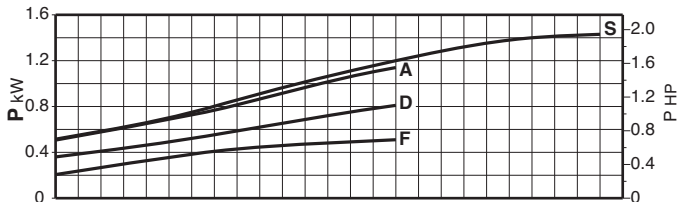
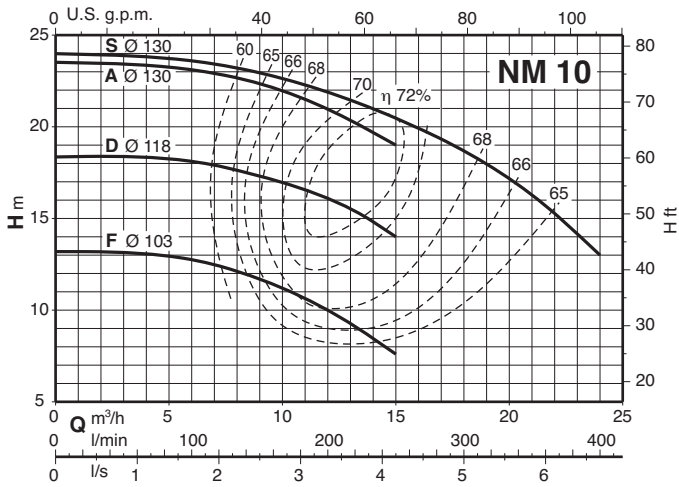

Kennlinien $n \approx 2900$ 1/min

1

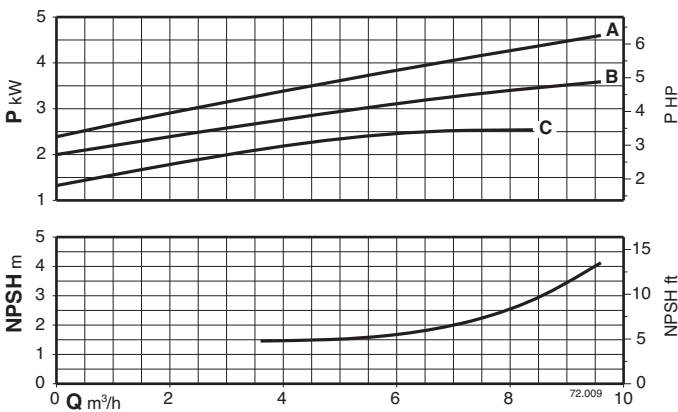
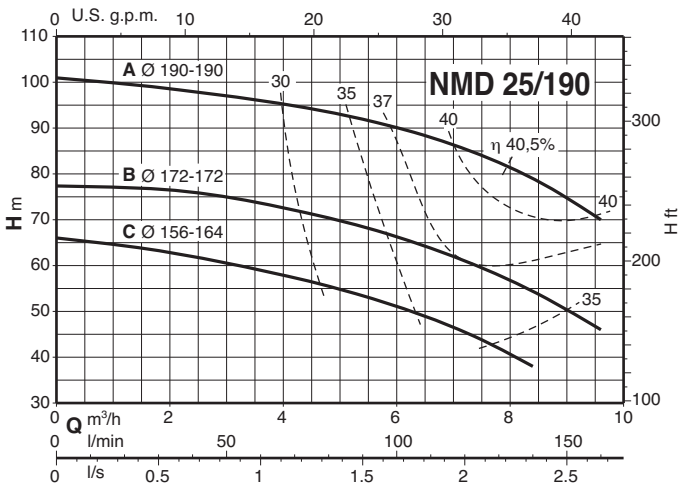
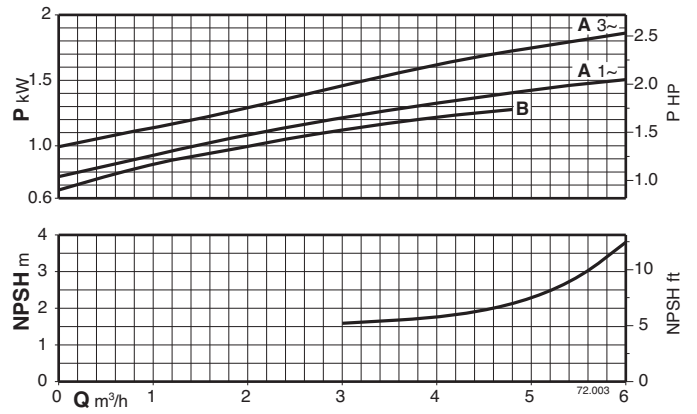
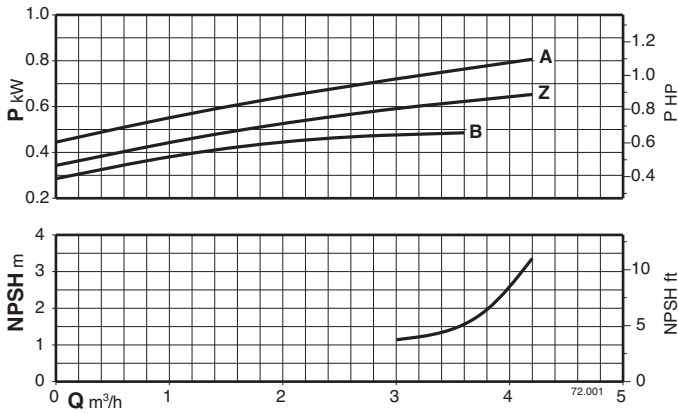
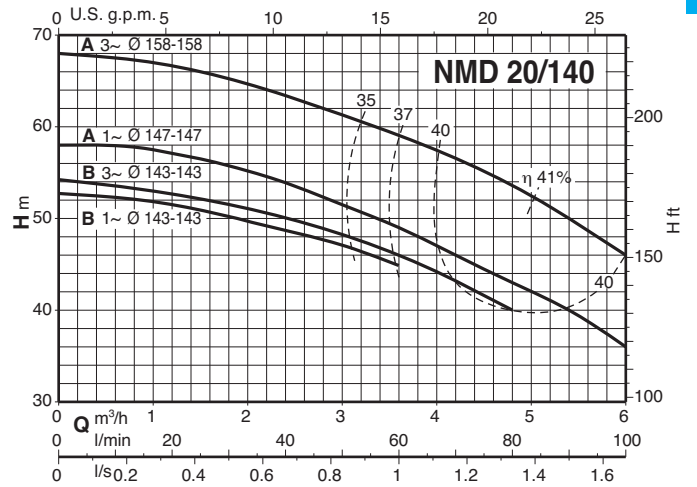
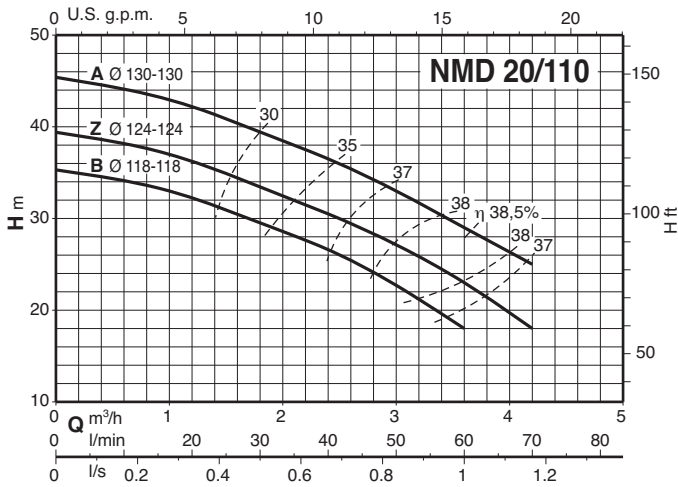

Kennlinien $n \approx 2900$ 1/min

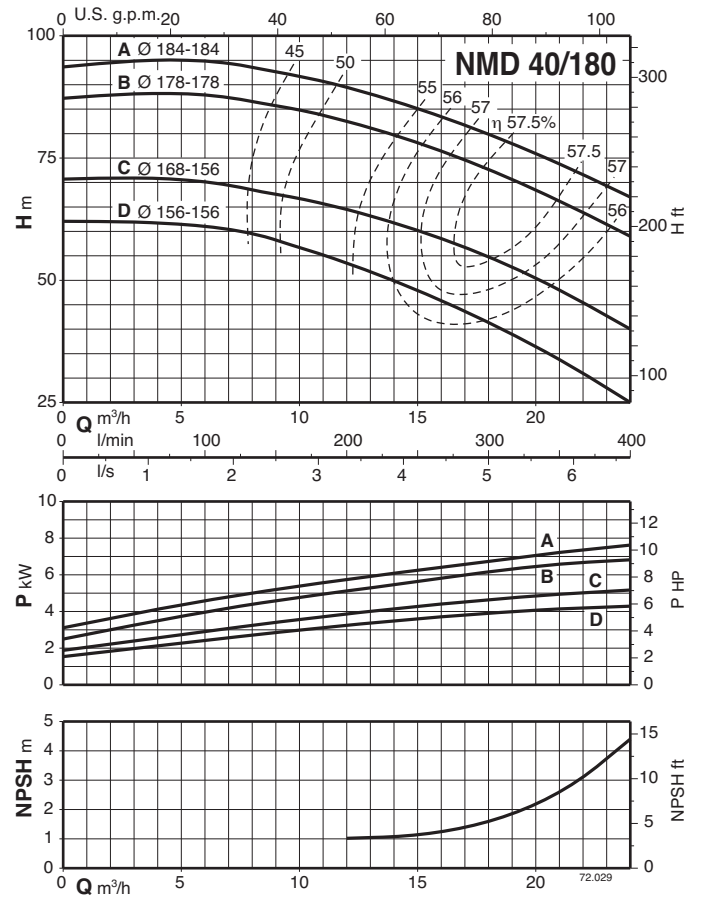
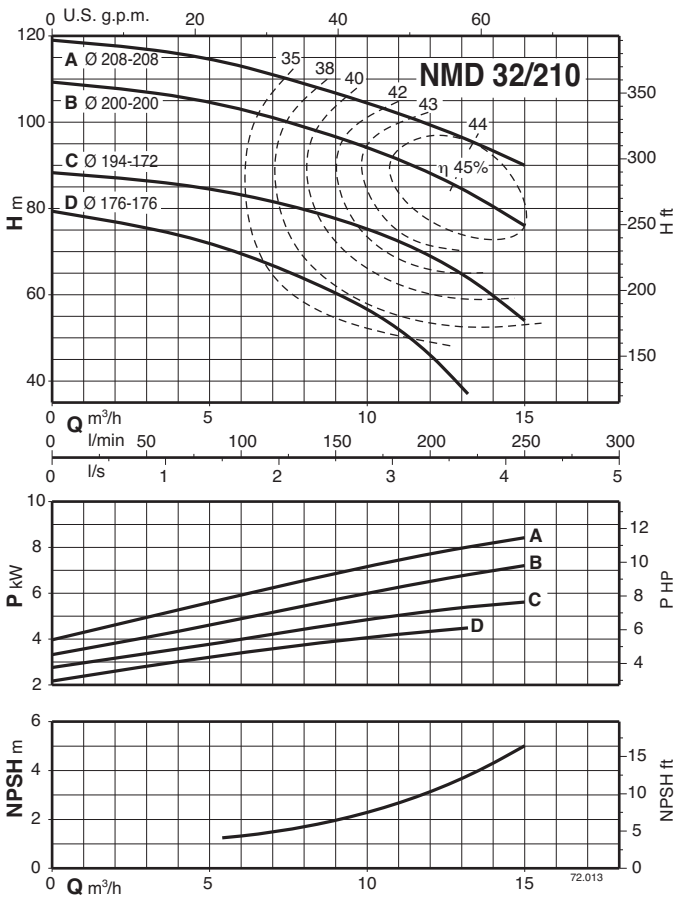

Abmessung und Gewicht

1

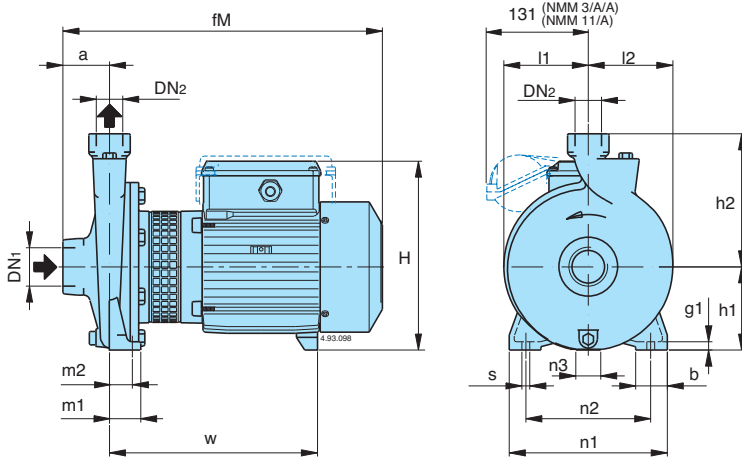

TYP	NMM kg	NM kg	B-NM kg
NM 1/AE	8,7	8,6	
NM 2/B/A	14	13,1	
NM 2/S/A	14,2	13,3	
NM 2/A/B	15,1	15	
NM 3/C/A	24	22,9	
NM 3/B/A	26	25,1	
NM 3/A/B	30,4	29,1	
B- NM 20/160BE	19,9	18,4	21
B- NM 20/160A/A	20,7	19,7	22,5
B- NM 25/12B/A	13,2	12,3	13,5
B- NM 25/12A/B	14,2	14,1	15,3
B- NM 25/160B/A	20,4	19,7	22,8
B- NM 25/160A/A	22,5	21,5	24
NM 25/20B/C		31,6	
NM 25/20A/B		40,9	
NM 25/20S/C		42,2	
B- NM 25/200B/C			35,7
B- NM 25/200A/C			43,7
B- NM 25/200S/C			45,2
NM 10/FE	19,3	18,5	
NM 10/DE	19,4	18,8	
NM 10/A/A	20,2	19,3	
NM 10/S/A	22,1	21,5	
NM 11/B/A	24,7	24,1	
NM 11/A/B		28,1	
NM 12/D/B		33,5	
NM 12/C/A		42	
NM 12/A/B		43,5	
B- NM 17/H/A	23	22,2	29,2
B- NM 17/G/A	24,2	23,2	30,2
B- NM 17/F/B		28,2	35,2
B- NM 17/D/A		36,2	43,2

B-NM	NM	DN ₁ ISO 228	DN ₂	mm															
				a	fM	h ₁	h ₂	H	m ₁	m ₂	n ₁	n ₂	n ₃	b	s	l ₁	l ₂	w	g ₁
	NM 1/AE	G 1	G 1	40	261	80	132	176	40	32	170	140	17	35	9,5	77	81	171	10
	NM 2/A/B-S/A-B/A	G 1	G 1	45	305	95	150	207	40	32	190	160	17	35	9,5	87	90	203	10
	NM 3/B/A-C/A	G 1	G 1	50	375	112	180	240	55	43	245	205	37	45	11,5	110	113	244	12
	NM 3/A/B				415													284	
B- NM 20/160A/A-BE	NM 20/160A/A-BE	G 1 1/4	G 3/4	53	375	100	150	228	37,5	27,5	190	150	30	38	9,5	102	102	246	10
B- NM 25/12A/B-B/A	NM 25/12A/B-B/A	G 1 1/2	G 1	56	313	90	140	199	37,5	27,5	170	130	9	38	9,5	85	88	195	10
B- NM 25/160A/A-B/A	NM 25/160A/A-B/A	G 1 1/2	G 1	56	380	100	160	228	37,5	27,5	190	150	30	38	9,5	102	102	246	10
	NM 25/20B/C	G 1 1/2	G 1	63	433	125	180	253	45	32,5	245	200	49	45	11,5	125	125	291	11
	NM 25/20A/B-S/C				460			263					42					295	
B- NM 25/200B/C		G 1 1/2	G 1	63	445	125	180	253	45	32,5	245	200	49	45	11,5	125	125	303	11
B- NM 25/200A/B-S/C					460			263					42					295	
	NM 10/S/A-A/A-DE-FE	G 2	G 1 1/4	63	382	100	150	228	50	35	190	140	30	50	13	90	97	239	14
	NM 11/B/A	G 2	G 1 1/4	70	400	112	170	240	50	35	210	160	37	50	15	103	110	247	14
	NM 11/A/B				440													287	
	NM 12/D/B	G 2	G 1 1/4	70	440	132	190	260	50	35	240	190	47	50	15	125	127	287	14
	NM 12/A/B-C/A				470			270					45					300	
B- NM 17/G/A-H/A	NM 17/G/A-H/A				417			240					37					257	
B- NM 17/F/B	NM 17/F/B	G 2 1/2	G 2 1/2	80	463	112	160	240	50	35	210	160	37	50	14	96	113	304	14
B- NM 17/D/A	NM 17/D/A				480			250					20					295	

Abmessung und Gewicht

NMD 20/110

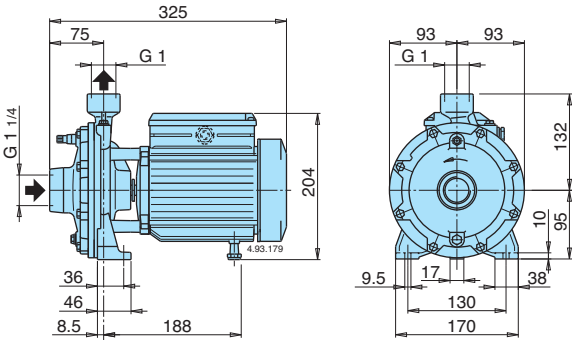

TYP	NMDM kg	NMD kg	B-NMD kg
B- NMD 20/110B/A	13	12,1	13,4
B- NMD 20/110Z/A	14	13	14,2
B- NMD 20/110A/B	15,1	14,2	17,4

NMD 20/140 NMD 25/190

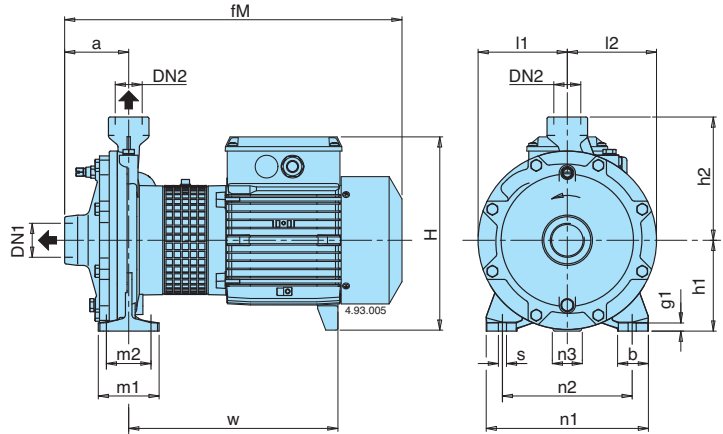

TYP	NMDM kg	NMD kg	B-NMD kg
B- NMD 20/140B/A	23,9	22,7	25,2
B- NMD 20/140A/A	25,2	24,8	27,6
B- NMD 25/190C/B		42	45,7
B- NMD 25/190B/A		49,7	54
B- NMD 25/190A/B		51,5	55,5

B-NMD	NMD	DN1 ISO 228	DN2 ISO 228	mm															
				a	fM	h1	h2	H	m1	m2	n1	n2	n3	b	s	l1	l2	w	g1
B- NMD 20/140A/A-B/A	NMD 20/140A/A-B/A	G 1 1/4	G 1	80	417	112	152	243	75	55	200	160	37	38	9,5	110	110	256	10
B- NMD 25/190C/B	NMD 25/190C/B	G 1 1/2	G 1	97	487	140	180	268	100	70	240	190	50	50	14	133	133	314	13
B- NMD 25/190A/B-B/B	NMD 25/190A/B-B/A				500			278					49					306	

NMD 32/210 NMD 40/180

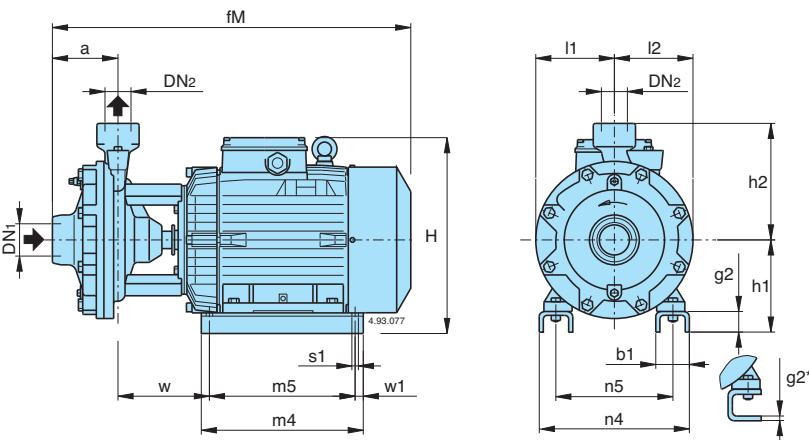

TYP	NMD kg	B-NMD kg
B- NMD 32/210D/B	60,5	66,5
B- NMD 32/210C/A	71	77
B- NMD 32/210B/A	77	82,5
B- NMD 32/210A/B	99	105
B- NMD 40/180D/B	59,5	65,5
B- NMD 40/180C/A	70	76
B- NMD 40/180B/A	76	81,5
B- NMD 40/180A/B	97	102

B-NMD	NMD	DN1 ISO 228	DN2 ISO 228	mm															
				a	fM	h1	h2	H	m4	m5	n4	n5	w1	b1	s1	l1	l2	w	g2
B- NMD 32/210D/B	NMD 32/210D/B				530	155		293	205	175	194	140		54	10			139	6*
B- NMD 32/210B/A -C/A	NMD 32/210B/A -C/A	G 2	G 1 1/4	110	550	150	215	310	280	250	258	190	15	68	12	150	150	108	38
B- NMD 32/210A/B	NMD 32/210A/B				625	170		355	298	268	286	216		70	12			152	38
B- NMD 40/180D/B	NMD 40/180D/B				535	155		293	205	175	194	140		54	10			133	6*
B- NMD 40/180B/A -C/A	NMD 40/180B/A -C/A	G 2	G 1 1/2	121	555	150	215	310	280	250	258	190	15	68	12	145	145	102	38
B- NMD 40/180A/B	NMD 40/180A/B				630	170		355	298	268	286	216		70	12			145	38

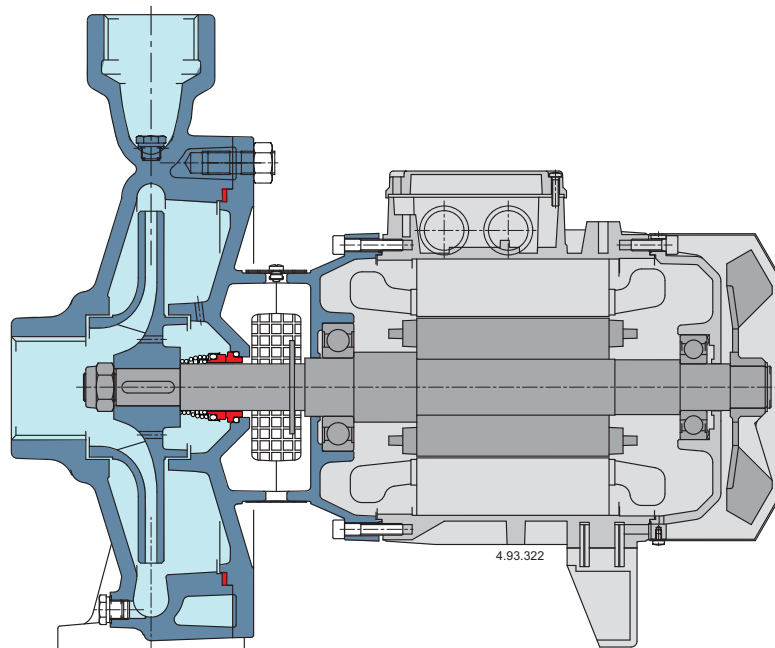

Kompaktes Design

Das kompakte Design erlaubt einfache Installation bei geringem Platzbedarf.

Robust

Die großzügige Dimensionierung der Hydraulikteile stellt eine maximale Beständigkeit gegen mechanische Belastungen sicher.

Einzigartige Konstruktion

Die Konstruktion der Antriebslaterne mit Berührungsschutz verhindert den Kontakt mit beweglichen Pumpenteilen, schützt das Servicepersonal und erlaubt dennoch eine Sichtprüfung der Wellenabdichtung.

Zuverlässig

Die Dimensionierung von Motorlager und Welle reduzieren die Belastung der Bauteile und ermöglichen hohe Betriebssicherheit über den gesamten Leistungsbereich.

Konstruktionsmerkmale

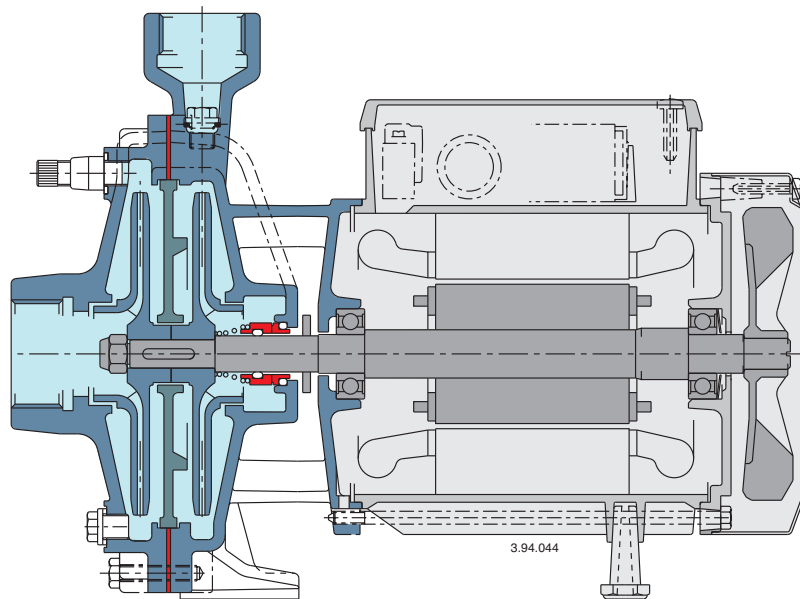

Flexibel

Die Verfügbarkeit von Grauguss und Bronze als Laufrad- und Gehäusewerkstoff ermöglicht den Einsatz der Serie NM und NMD mit verschiedenen Fördermedien.

Robust

Die großzügige Dimensionierung der Hydraulikteile stellt eine maximale Beständigkeit gegen mechanische Belastungen sicher.

Zuverlässig

Die Dimensionierung von Motorlager und Welle reduzieren die Belastung der Bauteile und ermöglichen hohe Betriebssicherheit über den gesamten Leistungsbereich.