

DRP

Multi-channel open impeller



All product images are indicative only

General characteristics

Multi-channel open impeller	
motor power	4,1 ÷ 19,3 kW
poles	2 / 4 / 6
discharge	DN80 ÷ DN150 horizontal
free passage	max 125 mm
max flow rate	140.9 l/s
max head	52.6 m

Electromechanical assembly

Electromechanical assembly in GJL-250 cast iron, for submerged operation. Seal set comprising 2 (two) silicon carbide mechanical seals installed in series in inspectable oil sump and 1 (one) opposed graphite-alumina lip seal lubricated by the motor oil. Oil bath motor.

Applications

Designed to transport heavily soiled wastewater, activated sludges and solids. Particularly suitable for applications in wastewater treatment plants, sewer systems, civil lifting systems and the paper, tanning and leather industries.

Construction materials

Case	Cast iron EN-GJL 250
Impeller	Cast iron EN-GJL-250
Nuts and bolts	Stainless steel - Class A2-70
Standard gasket	Rubber - NBR
Shaft	Stainless steel - AISI 420
Cooling jacket	Carbon steel or AISI 304 stainless steel
Paint type	Ecological bicomponent epoxy (medium thickness 150 µm)
Set of standard mechanical seals	Two silicon carbide mechanical seals (2SiC) and one carbon-aluminium oxide mechanical seal (AL)

Operating limits

Maximum operating temperature	40 °C
PH of treated fluid	6 ÷ 14
Viscosity of treated fluid	1 mm ² /s
Maximum immersion depth	20 m
Density of treated fluid	1 Kg/dm ³
Maximum acoustic pressure	70 dB
max starts per hour	20

DRP

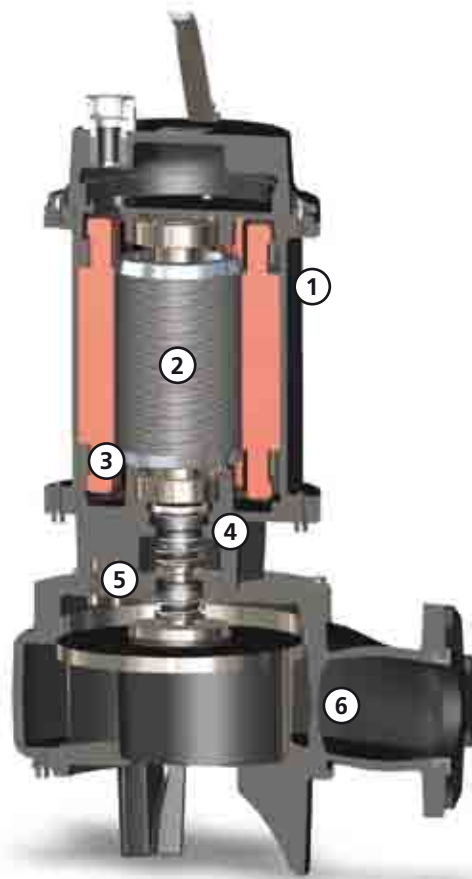

Structure

Constructed in GJL-250 cast iron.

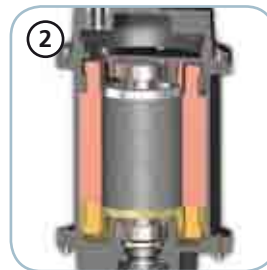

Motor

Oil-bath motor with thermal protections.

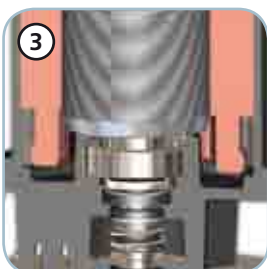

Bearings

Shielded ball bearings with lifetime autolubrication.



Mechanical seals

Two mechanical seals in silicon carbide (2SiC) and one mechanical seal in alumina graphite (AL) for maximum reliability even in heavy-duty applications.



Oil sump

Large oil sump to guarantee longer mechanical seal lifetime.



Free passage

Wide free passage allowing the expulsion of solids and preventing fouling of the impeller.

DRP

Models with horizontal DN80 PN10-16 flanged discharge - 2 poles

Performances

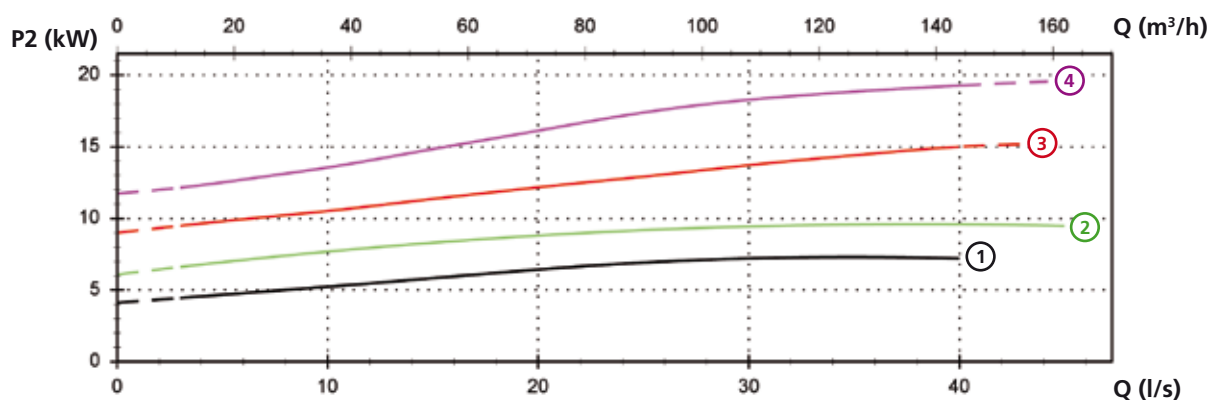
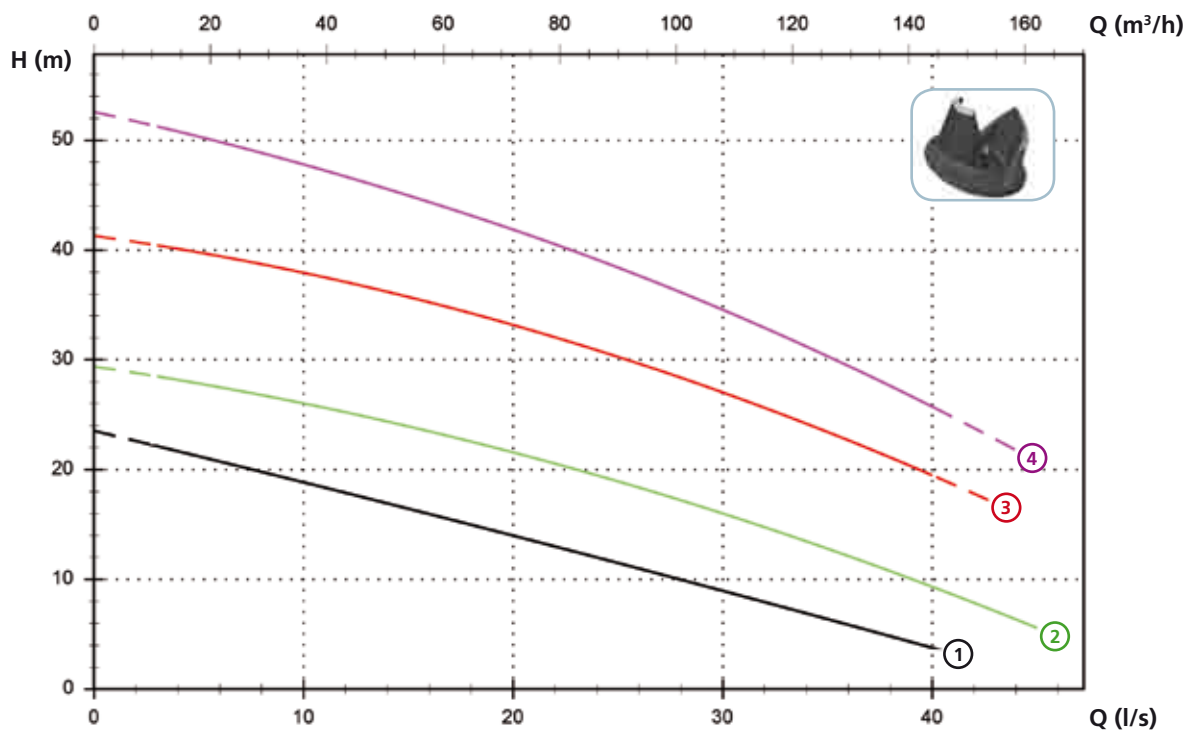

Technical data

	V	Phases	P1 (kW)	P2 (kW)	A	Rpm	Start	Ø	Free passage	
①	DRP 750/2/80 A0HT/50	400	3	8.8	7.2	14.5	2900	Y Δ	DN80 PN10-16	55x65 mm
②	DRP 1000/2/80 A1HT/50	400	3	12.4	10	19.8	2900	Y Δ	DN80 PN10-16	55x65 mm
③	DRP 1500/2/80 A0HT/50	400	3	16.7	15	27.2	2900	Y Δ	DN80 PN10-16	50x60 mm
④	DRP 2000/2/80 A0IT/50	400	3	22.7	19.3	36	2900	Y Δ	DN80 PN10-16	35x60 mm

Models with horizontal DN100 PN10-16 flanged discharge - 2 poles

Performances

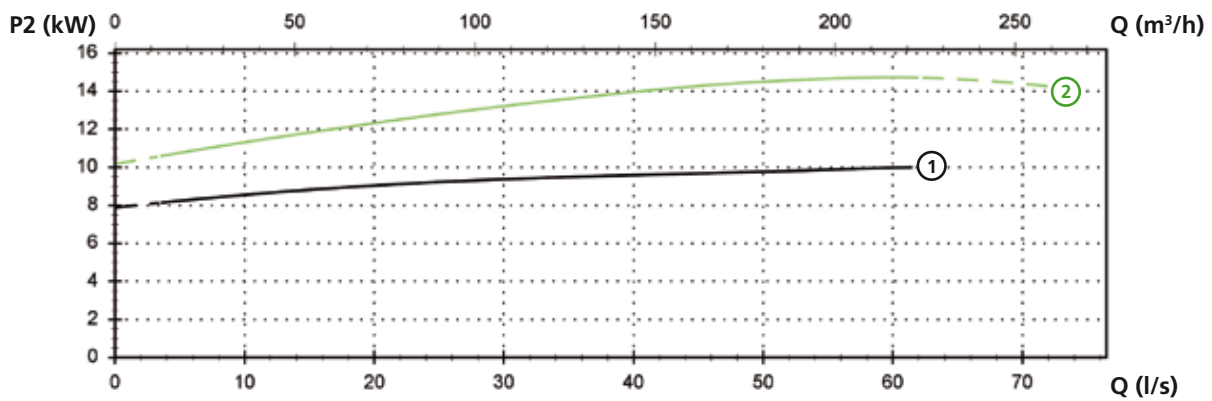
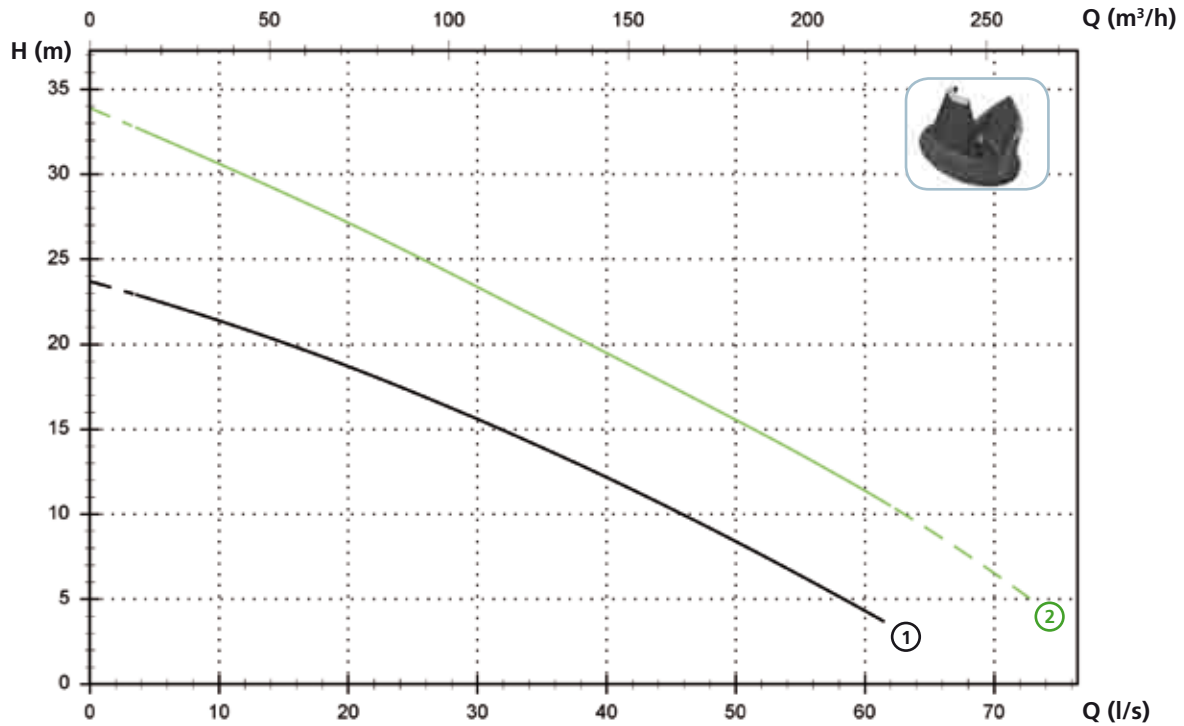

Technical data

	V	Phases	P1 (kW)	P2 (kW)	A	Rpm	Start	Ø	Free passage	
①	DRP 1000/2/100 A1HT/50	400	3	12.4	10	19.8	2900	Y Δ	DN100 PN10-16	75x80 mm
②	DRP 1500/2/100 A0HT/50	400	3	17.7	15	28.2	2900	Y Δ	DN100 PN10-16	70x80 mm

DRP

Models with horizontal DN80 PN10/10-16 flanged discharge - 4 poles

Performances

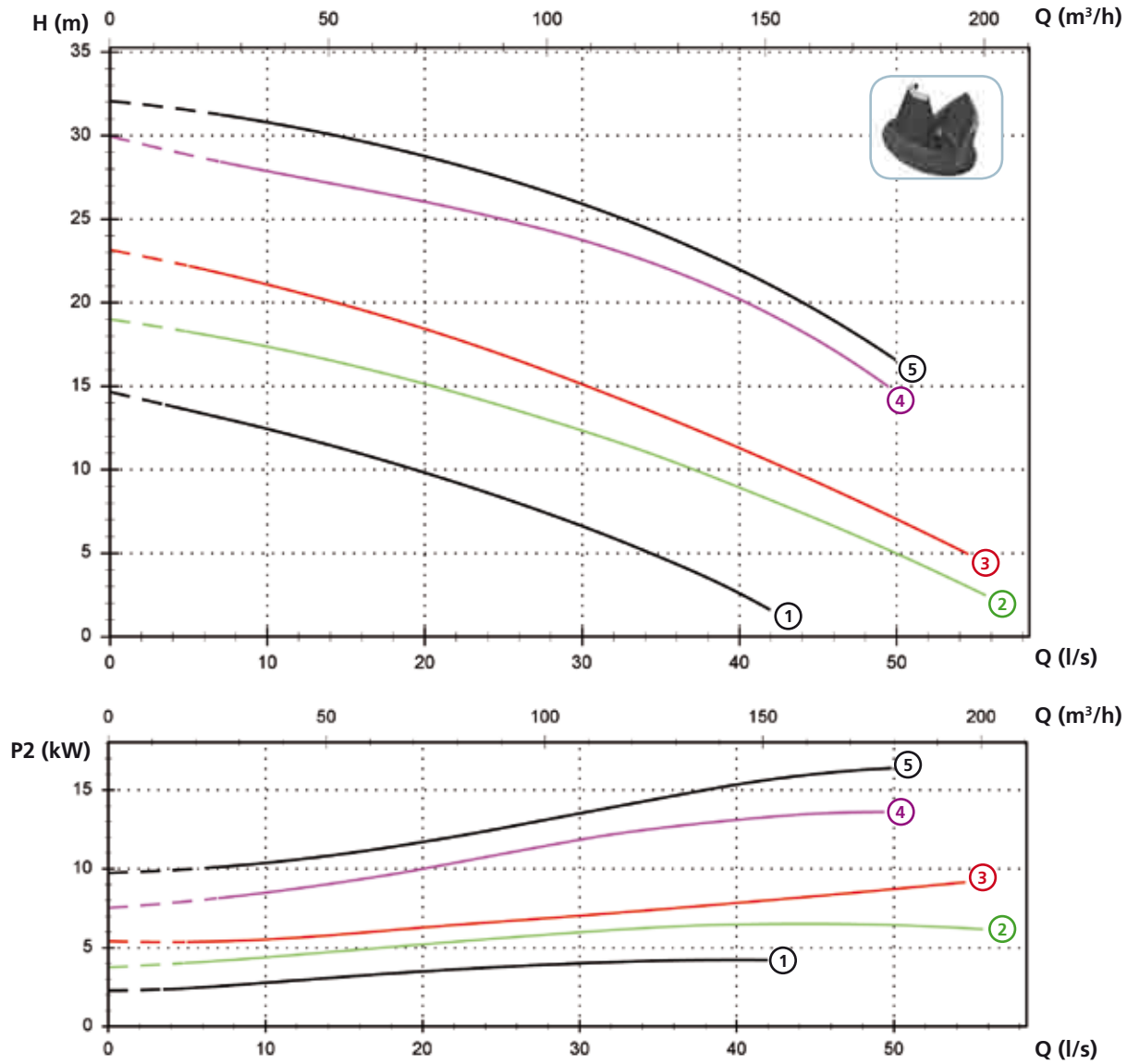

Technical data

	V	Phases	P1 (kW)	P2 (kW)	A	Rpm	Start	Ø	Free passage	
①	DRP 550/4/80 A0GT/50	400	3	5.9	4.6	10.1	1450	Dir	DN80 PN10-16	60x70 mm
②	DRP 750/4/80 A0HT/50	400	3	8.6	6.5	14.9	1450	Y Δ	DN80 PN10-16	60x70 mm
③	DRP 1000/4/80 A0HT/50	400	3	11.5	8.9	20	1450	Y Δ	DN80 PN10-16	60x70 mm
④	DRP 1500/4/80 A0IT/50	400	3	15.8	13.6	28.2	1450	Y Δ	DN80 PN10	50x70 mm
⑤	DRP 2000/4/80 A0IT/50	400	3	20.7	16.4	36	1450	Y Δ	DN80 PN10	50x70 mm

Models with horizontal DN100 PN10-16 flanged discharge - 4 poles

Performances

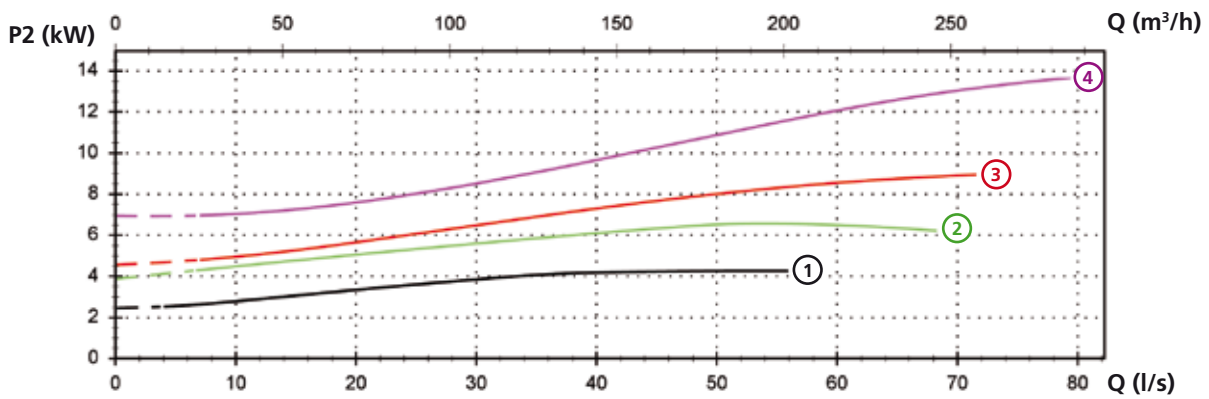
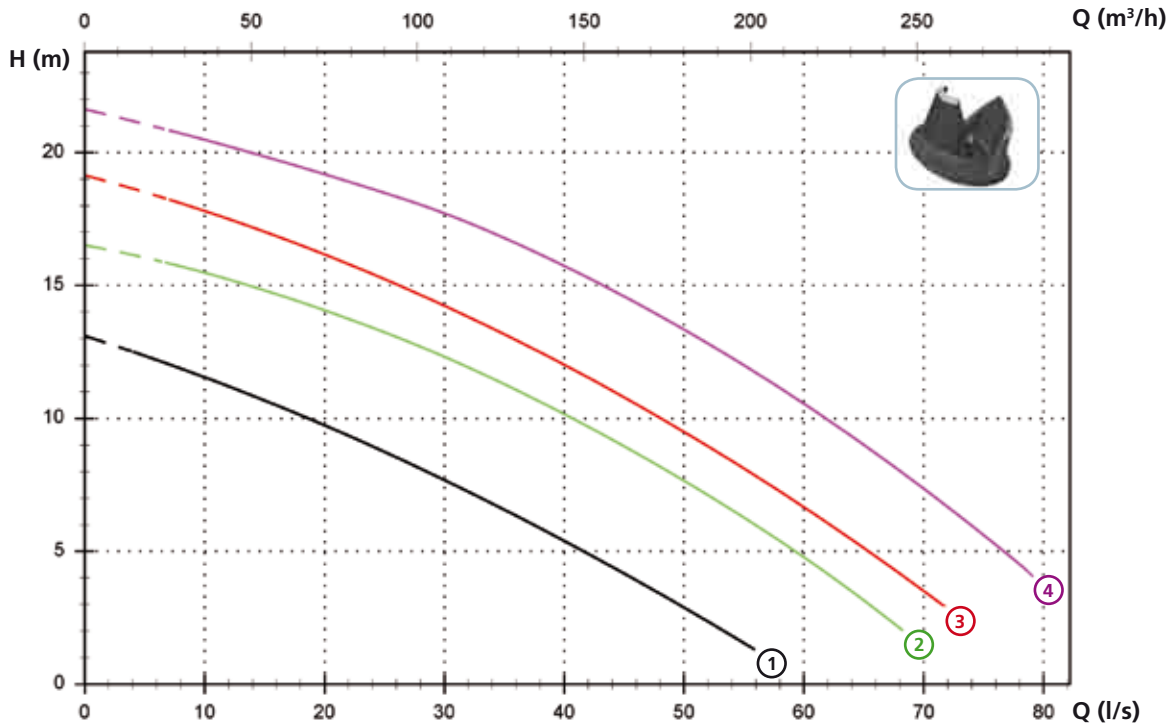

Technical data

	V	Phases	P1 (kW)	P2 (kW)	A	Rpm	Start	Ø	Free passage	
①	DRP 550/4/100 A0GT/50	400	3	5.9	4.6	10.1	1450	Dir	DN100 PN10-16	65x70 mm
②	DRP 750/4/100 A0HT/50	400	3	8.6	6.5	14.9	1450	Y Δ	DN100 PN10-16	85x95 mm
③	DRP 1000/4/100 A0HT/50	400	3	11.5	8.9	20	1450	Y Δ	DN100 PN10-16	80x95 mm
④	DRP 1500/4/100 A0IT/50	400	3	15.8	13.6	28.2	1450	Y Δ	DN100 PN10-16	70x95 mm

DRP

Models with horizontal DN125 PN10 flanged discharge - 4 poles

Performances

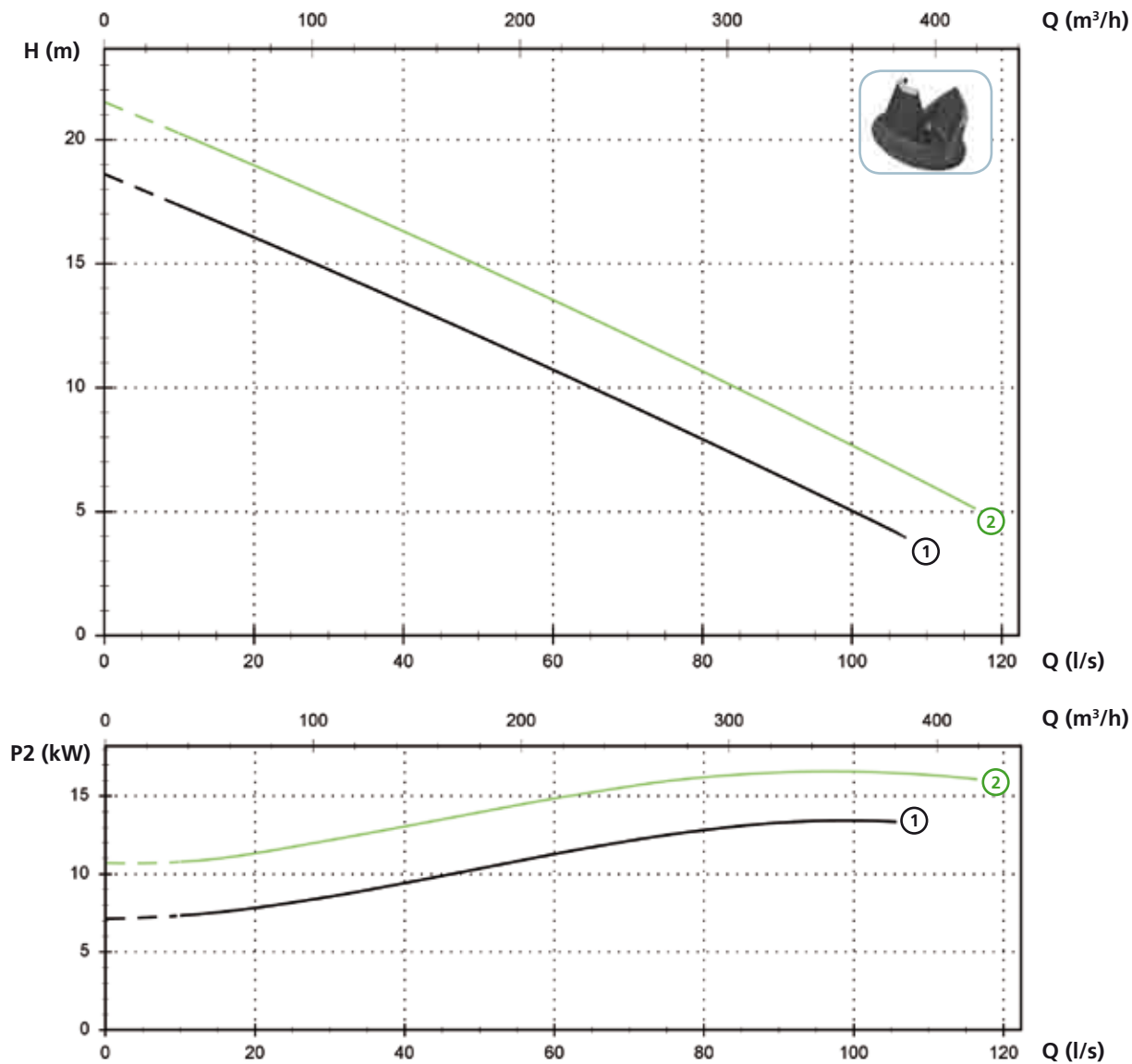

Technical data

	V	Phases	P1 (kW)	P2 (kW)	A	Rpm	Start	Ø	Free passage	
①	DRP 1500/4/125 A0IT/50	400	3	15.8	13.6	28.2	1450	Y Δ	DN125 PN10	90x105 mm
②	DRP 2000/4/125 A0IT/50	400	3	20.7	16.4	36	1450	Y Δ	DN125 PN10	90x105 mm

Models with horizontal DN150 PN10-16 flanged discharge - 4 poles

Performances

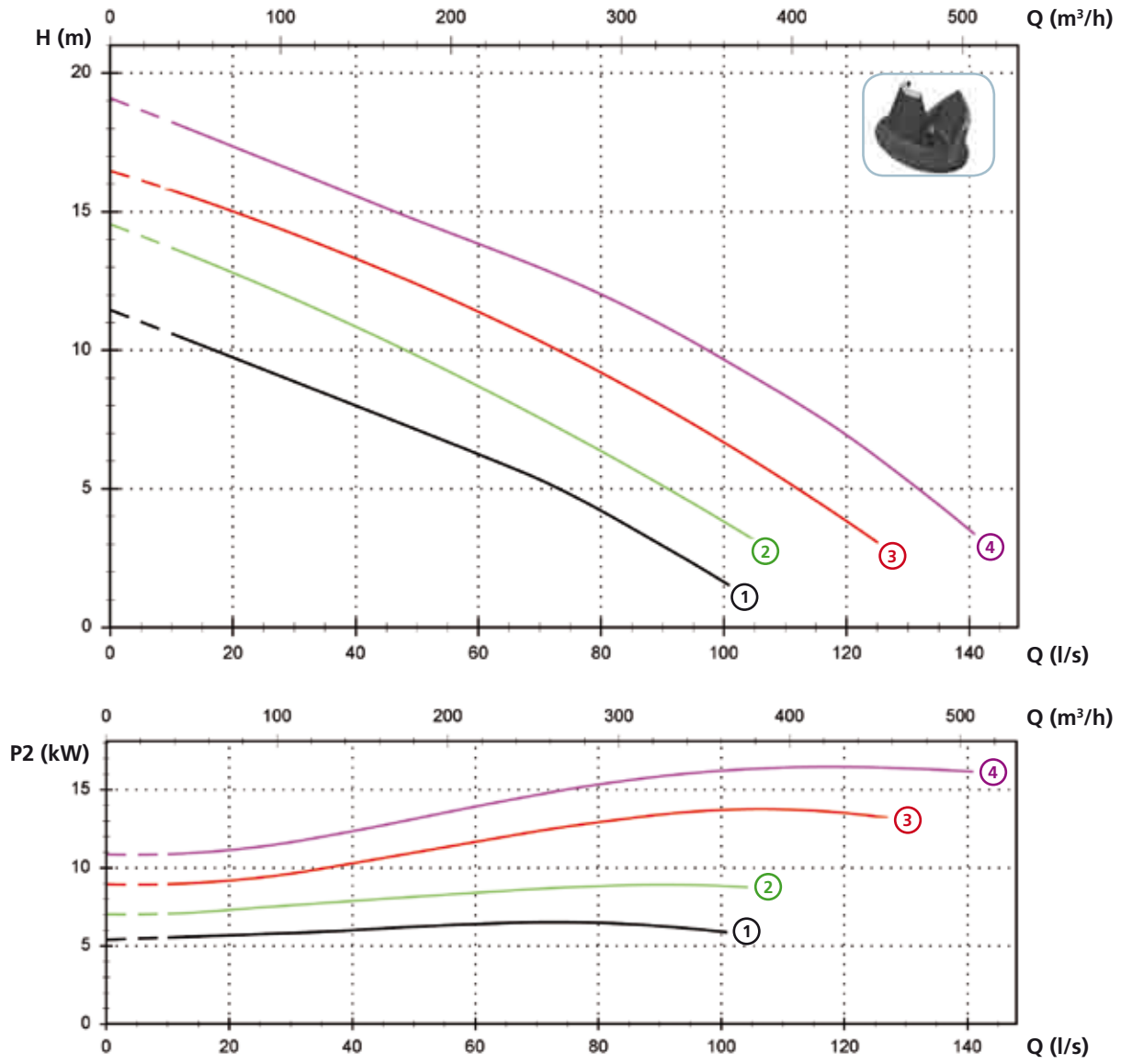

Technical data

	V	Phases	P1 (kW)	P2 (kW)	A	Rpm	Start	Ø	Free passage	
①	DRP 750/4/150 A0HT/50	400	3	8.6	6.5	14.9	1450	Y Δ	DN150 PN10-16	95 mm
②	DRP 1000/4/150 A0HT/50	400	3	11.5	8.9	20	1450	Y Δ	DN150 PN10-16	95 mm
③	DRP 1500/4/150 A0IT/50	400	3	15.8	13.6	28.2	1450	Y Δ	DN150 PN10-16	95x110 mm
④	DRP 2000/4/150 A0IT/50	400	3	20.7	16.4	36	1450	Y Δ	DN150 PN10-16	95x115 mm

DRP

Models with horizontal DN150 PN10-16 flanged discharge - 6 poles

Performances

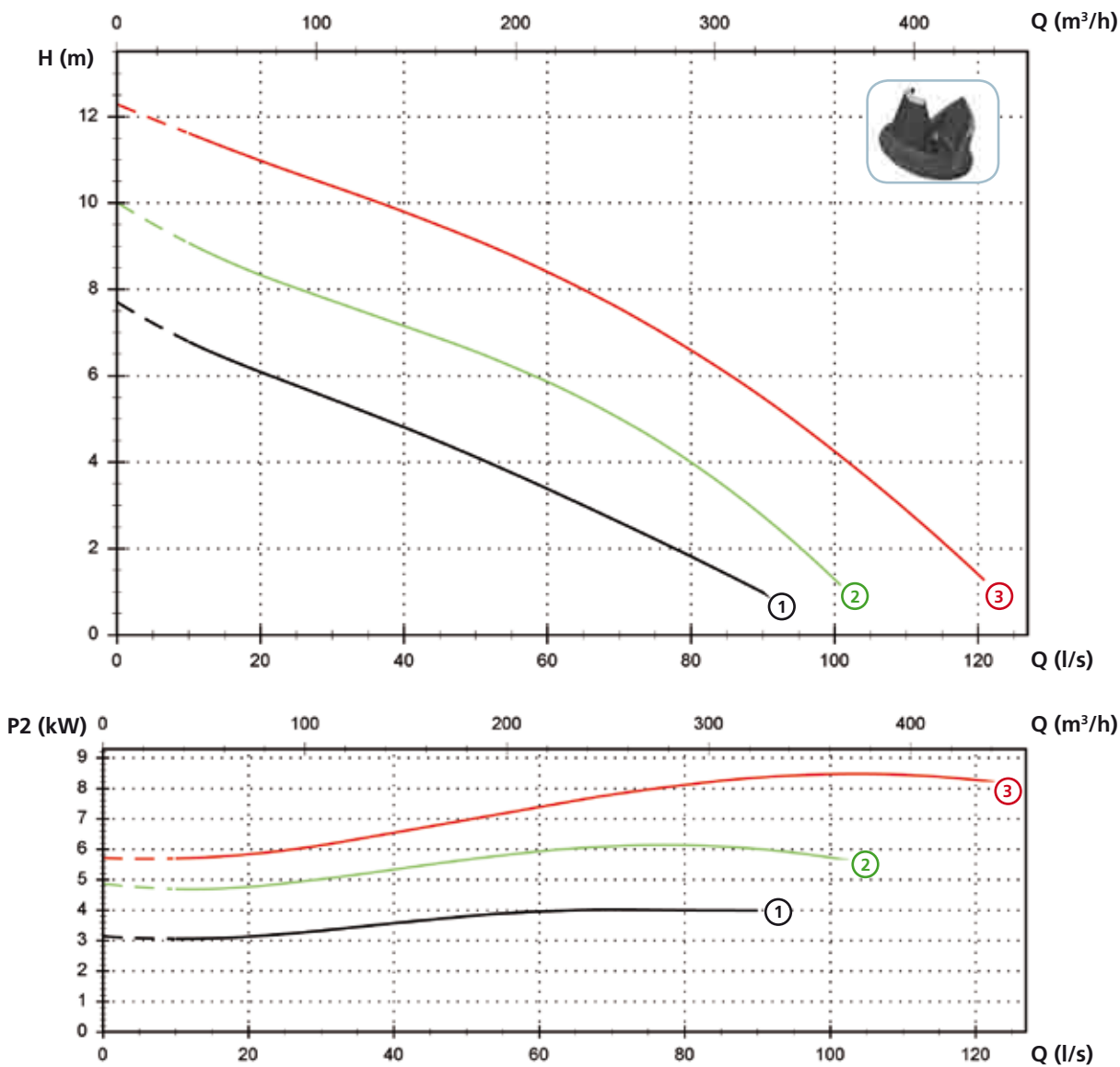

Technical data

	V	Phases	P1 (kW)	P2 (kW)	A	Rpm	Start	Ø	Free passage	
①	DRP 550/6/150 A0HT/50	400	3	5.3	4.1	10.7	960	Y Δ	DN150 PN10-16	115 mm
②	DRP 750/6/150 A0HT/50	400	3	7.8	6.1	15.2	960	Y Δ	DN150 PN10-16	110x125 mm
③	DRP 1000/6/150 A0IT/50	400	3	11.4	8.4	20.1	960	Y Δ	DN150 PN10-16	95x115 mm

Versions available

(Key to versions on page 16)

	Electrical variants											Cooling				Mechanical seals				
	N A E	T	T C	T C D	T C D T	T C D G T	T C G	T C S T	T C S G T	T S	T R	T R G	N	CC CCE	FT	C G F T	2SIC	SICM	SICAL	2SICAL
DRP 750/2/80 A0HT/50		●										●	●							●
DRP 1000/2/80 A1HT/50		●										●	●							●
DRP 1500/2/80 A0HT/50		●										●	●							●
DRP 2000/2/80 A0IT/50		●										●	●							●
DRP 1000/2/100 A1HT/50		●										●	●							●
DRP 1500/2/100 A0HT/50		●										●	●							●
DRP 550/4/80 A0GT/50		●										●	●							●
DRP 750/4/80 A0HT/50		●										●	●							●
DRP 1000/4/80 A0HT/50		●										●	●							●
DRP 1500/4/80 A0IT/50		●										●	●							●
DRP 2000/4/80 A0IT/50		●										●	●							●
DRP 550/4/100 A0GT/50		●										●	●							●
DRP 750/4/100 A0HT/50		●										●	●							●
DRP 1000/4/100 A0HT/50		●										●	●							●
DRP 1500/4/100 A0IT/50		●										●	●							●
DRP 1500/4/125 A0IT/50		●										●	●							●
DRP 2000/4/125 A0IT/50		●										●	●							●
DRP 750/4/150 A0HT/50		●										●	●							●
DRP 1000/4/150 A0HT/50		●										●	●							●
DRP 1500/4/150 A0IT/50		●										●	●							●
DRP 2000/4/150 A0IT/50		●										●	●							●
DRP 550/6/150 A0HT/50		●										●	●							●
DRP 750/6/150 A0HT/50		●										●	●							●
DRP 1000/6/150 A0IT/50		●										●	●							●

DRP

Overall dimensions and weights

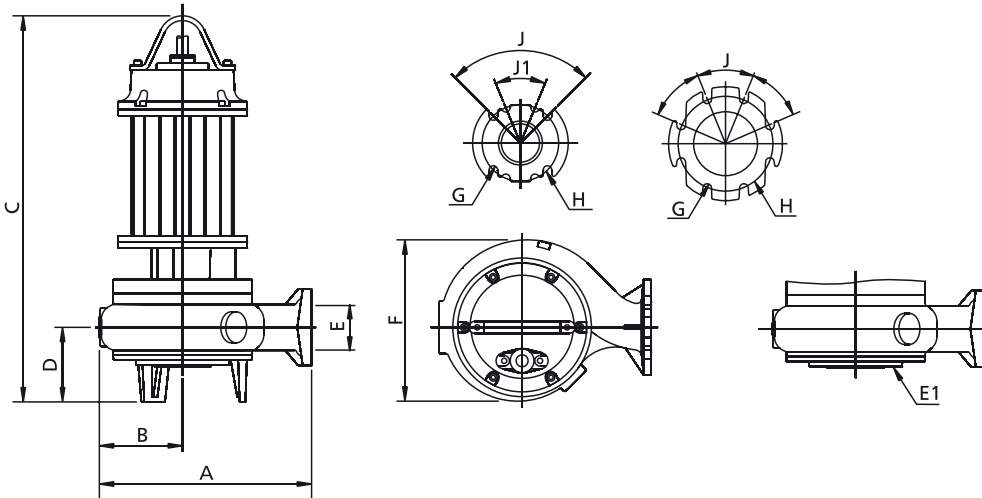

	A	B	C	D	E	E1 (*)	F	G	H	J	J1	kg
DRP 750/2/80 A0HT/50	390	150	770	150	80	-	295	18	160	90°	45°	100
DRP 1000/2/80 A1HT/50	390	150	770	150	80	-	295	18	160	90°	45°	105
DRP 1500/2/80 A0HT/50	390	150	770	150	80	-	295	18	160	90°	45°	128
DRP 2000/2/80 A0IT/50	390	150	935	150	80	DN80 PN6	310	18	160	90°	45°	158
DRP 1000/2/100 A1HT/50	415	160	798	155	100	-	310	18	180	45°	-	108
DRP 1500/2/100 A0HT/50	415	160	830	155	100	-	310	18	180	45°	-	130
DRP 550/4/80 A0GT/50	390	150	725	150	80	DN80 PN6	290	18	160	90°	45°	82
DRP 750/4/80 A0HT/50	445	175	810	155	80	DN80 PN6	340	18	160	90°	45°	125
DRP 1000/4/80 A0HT/50	445	175	810	155	80	DN80 PN6	340	18	160	90°	45°	133
DRP 1500/4/80 A0IT/50	455	200	950	150	80	-	435	18	160	90°	-	181
DRP 2000/4/80 A0IT/50	455	200	950	150	80	-	435	18	160	90°	-	196
DRP 550/4/100 A0GT/50	415	160	740	155	100	-	310	18	180	45°	-	85
DRP 750/4/100 A0HT/50	430	165	820	160	100	DN100 PN6	335	18	180	45°	-	123
DRP 1000/4/100 A0HT/50	430	165	820	160	100	DN100 PN6	335	18	180	45°	-	131
DRP 1500/4/100 A0IT/50	430	165	970	160	100	DN100 PN6	335	18	180	45°	-	171
DRP 1500/4/125 A0IT/50	580	280	1010	200	125	DN150 PN10	555	18	210	90°	-	199
DRP 2000/4/125 A0IT/50	580	280	1010	200	125	DN150 PN10	555	18	210	90°	-	220
DRP 750/4/150 A0HT/50	500	215	845	190	150	DN150 PN6	400	24	240	45°	-	138
DRP 1000/4/150 A0HT/50	500	215	845	190	150	DN150 PN6	400	24	240	45°	-	146
DRP 1500/4/150 A0IT/50	650	255	1020	205	150	DN150 PN10	505	24	240	45°	-	213
DRP 2000/4/150 A0IT/50	650	255	1020	205	150	DN150 PN10	505	24	240	45°	-	228
DRP 550/6/150 A0HT/50	500	215	865	190	150	DN150 PN6	400	24	240	45°	-	141
DRP 750/6/150 A0HT/50	650	255	900	205	150	DN150 PN10	505	24	240	45°	-	138
DRP 1000/6/150 A0IT/50	650	255	1019	205	150	DN150 PN10	505	24	240	45°	-	213

Dimensions in mm

All weights and dimensions are indicative only

(*) Suction flange available upon request

Installations available

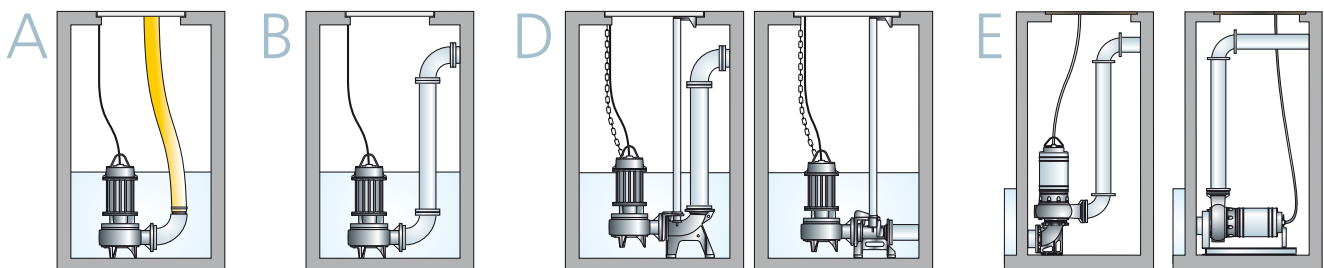

Packaging dimension

	A	B	C
DRP 750/2/80 A0HT/50	915	515	555
DRP 1000/2/80 A1HT/50	915	515	555
DRP 1500/2/80 A0HT/50	915	515	555
DRP 2000/2/80 A0IT/50	915	515	555
DRP 1000/2/100 A1HT/50	915	515	555
DRP 1500/2/100 A0HT/50	915	515	555
DRP 550/4/80 A0GT/50	725	445	415
DRP 750/4/80 A0HT/50	915	515	555
DRP 1000/4/80 A0HT/50	915	515	555
DRP 1500/4/80 A0IT/50	915	515	555
DRP 2000/4/80 A0IT/50	915	515	555
DRP 550/4/100 A0GT/50	725	445	415
DRP 750/4/100 A0HT/50	915	515	555
DRP 1000/4/100 A0HT/50	915	515	555
DRP 1500/4/100 A0IT/50	915	515	555
DRP 1500/4/125 A0IT/50	1165	720	685
DRP 2000/4/125 A0IT/50	1165	720	685
DRP 750/4/150 A0HT/50	915	515	555
DRP 1000/4/150 A0HT/50	915	515	555
DRP 1500/4/150 A0IT/50	1165	720	685
DRP 2000/4/150 A0IT/50	1165	720	685
DRP 550/6/150 A0HT/50	1165	720	685
DRP 750/6/150 A0HT/50	1165	720	685
DRP 1000/6/150 A0IT/50	1165	720	685

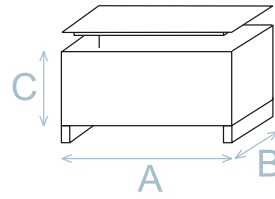

Dimension in mm

All weights and dimensions are indicative only