

NCE G.F Energy saving circulating pumps with flanges



Construction

Energy saving variable speed circulating pump driven by a permanent magnet synchronous motor (pm) controlled by on board inverter.

Applications

Heating, conditioning, circulating systems.
For civil and industrial applications.

Operating conditions

- Liquid temperature from -10 °C to +110 °C
- Ambient temperature from 0 °C to +40 °C
- Maximum permissible working pressure: 6/10 bar
- Storage: -20°C/+70°C max. relative humidity 95% at 40 °C
- Certifications: in conformity with CE requirements
- Sound pressure \leq 54 dB (A).
- Minimum suction pressure:
 - 0,5 bar at 50 °C.
 - 0,8 bar at 80 °C.
 - 1,4 bar at 110 °C.
- Maximum glycol quantity: 20%.
- EMC according to: EN 55014-1, EN 55014-2
EN 61000-3-2, EN 61000-3-2.
- Connections: Flanges according to PN 6/10, EN 1092-2, DN 50, 65, 80, 100.
- The benchmark for most efficient circulators is $EEL \leq 0,20$.

Designation

NCE G 40 F - 120 / 250

Series _____

Version _____

DN ports in mm _____

With flanges _____

Max. head in dm _____

connection size mm _____

Motor

Synchronous motor with permanent magnet.

- Motor: variable speed
- Standard voltage: single-phase 230 V (-10%;+6%)
- Frequency: 50-60 Hz
- Protection: IP 44
- Insulation class: H
- Overload protection (integrated).
- Cable: phases and neutral.
- Constructed in accordance with: EN 60335-1, EN 60335-2-51.

Features

Smart pump

NCE G.F adapt its functions to the system: the circulator measures the pressure and the flow and adjusts the speed to the selected pressure.

Easy use

There are different operating modes selectable from the control panel.

Operating modes



Automatic mode

(factory setting):

In this mode the pump automatically sets the operating pressure, depending on the hydraulic system. This mode is recommended in most systems.



Proportional pressure mode:

The circulator changes the pressure proportionally to the current flow. The pressure value can be adjusted with the + and - buttons.



Constant pressure mode:

The circulator maintains the pressure constant when the reference flow changes. The pressure value can be adjusted with the + and - buttons.



Fixed speed mode:

The circulator works with constant curve and the curve could be changed using + e - buttons.

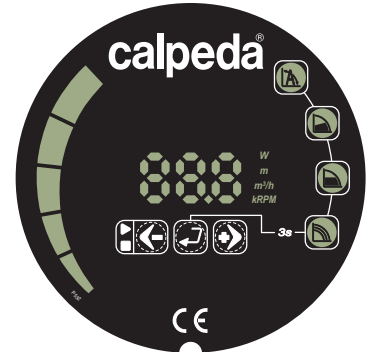

Operating mode-control panel

NCE G.F could works in:

- automatic mode
- proportional pressure mode
- constant pressure mode
- fixed speed mode

Coverage chart

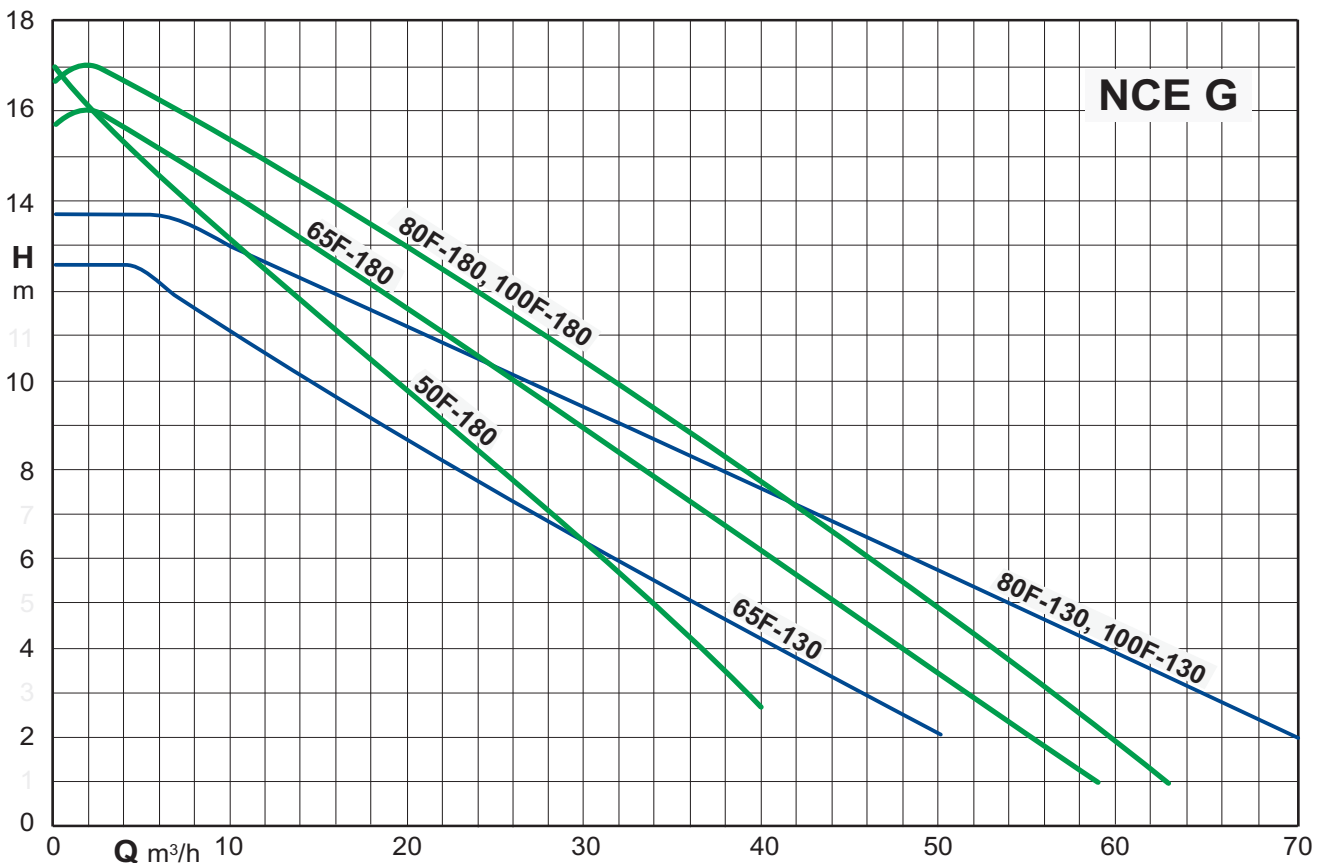

Characteristic curves

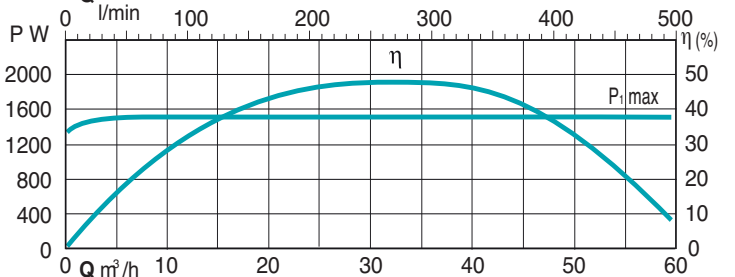
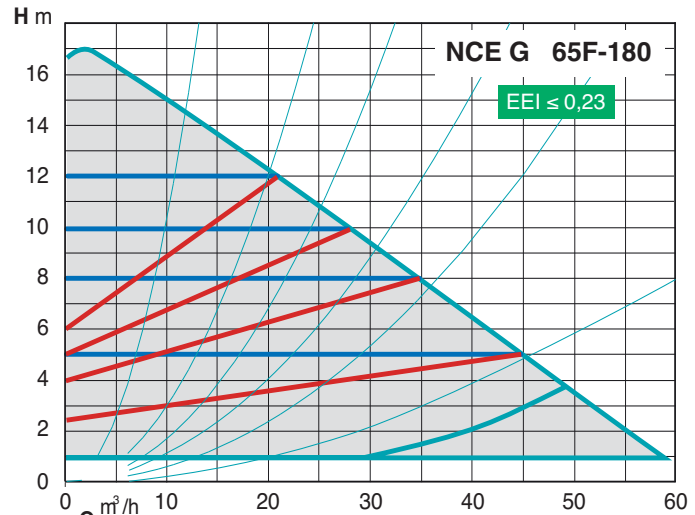
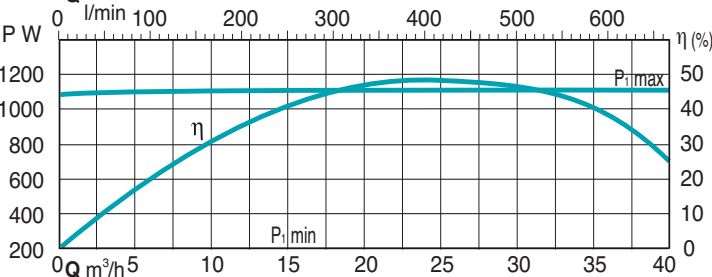
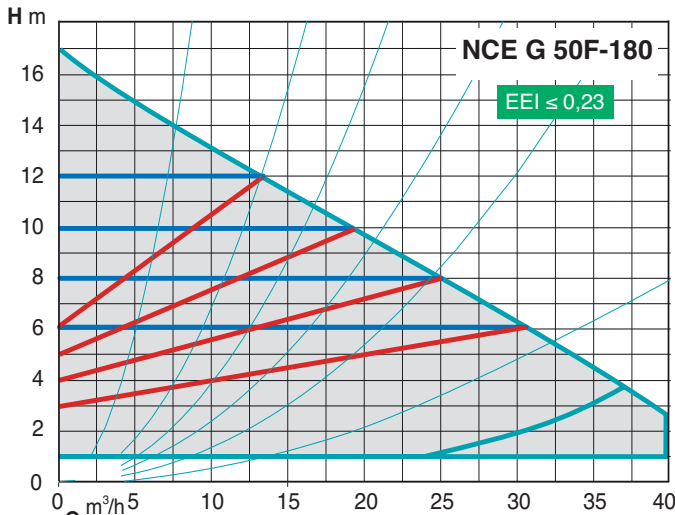
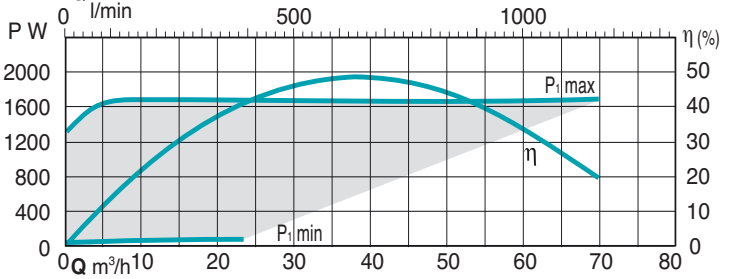
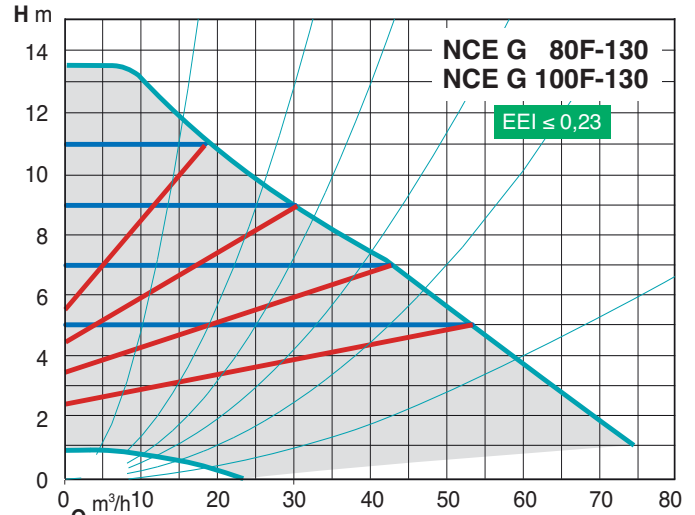
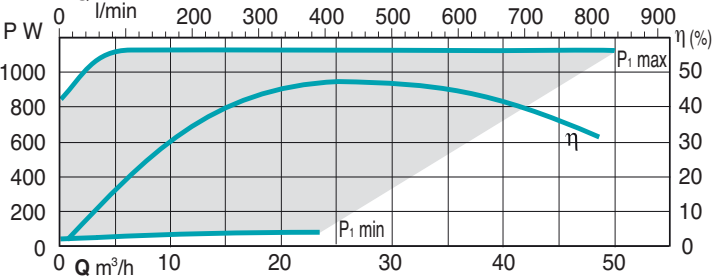
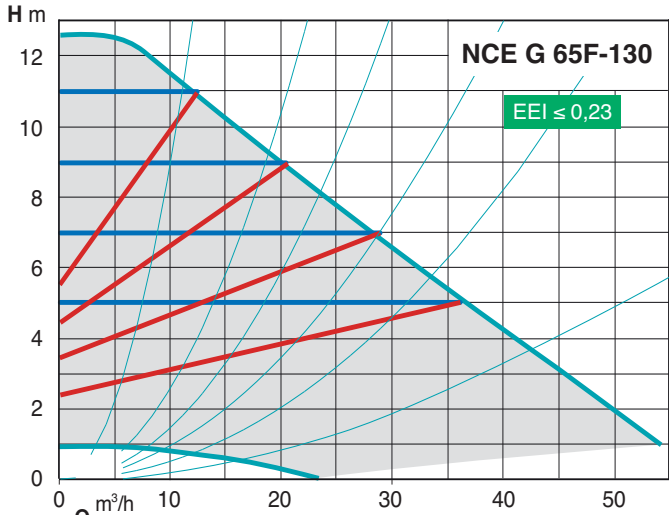

Characteristic curves

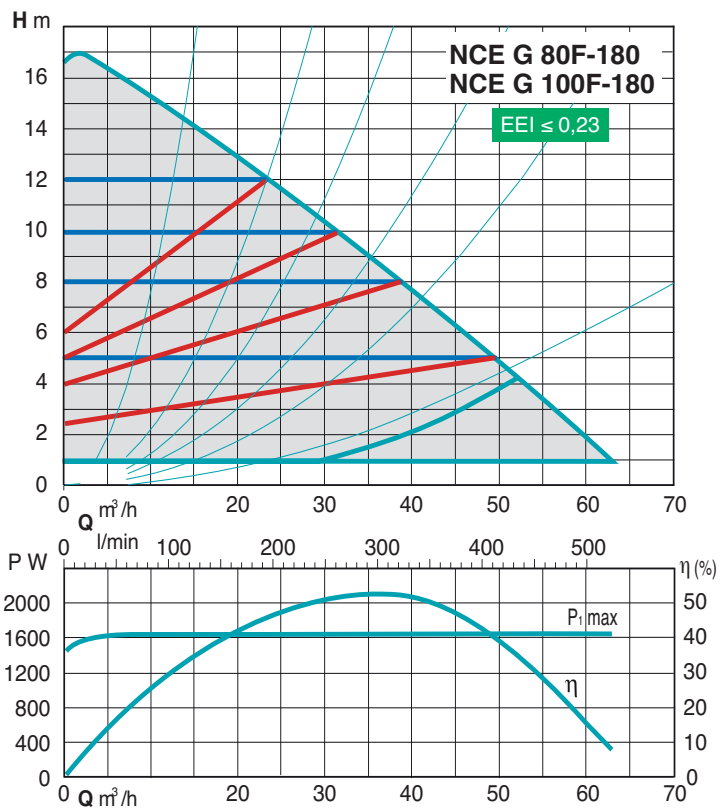

Materials

Component	Pos.	Material
Pump casing	1	Cast iron
Impeller	2	Stainless steel
Shaft	3	Stainless steel
Bearings	4	Carbon
Thrust bearing	5	Steel
Rotor	6	Stainless steel jacket
Winding	7	Copper wire
Electronic card	8	-
Gasket	9	EPDM

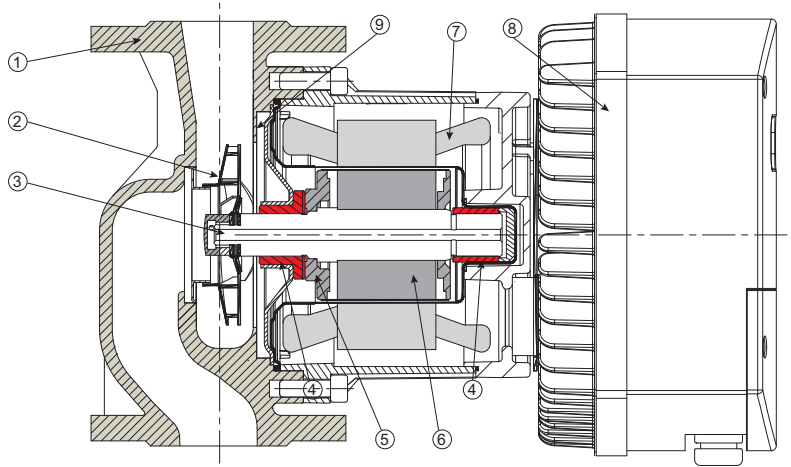

Examples of installations

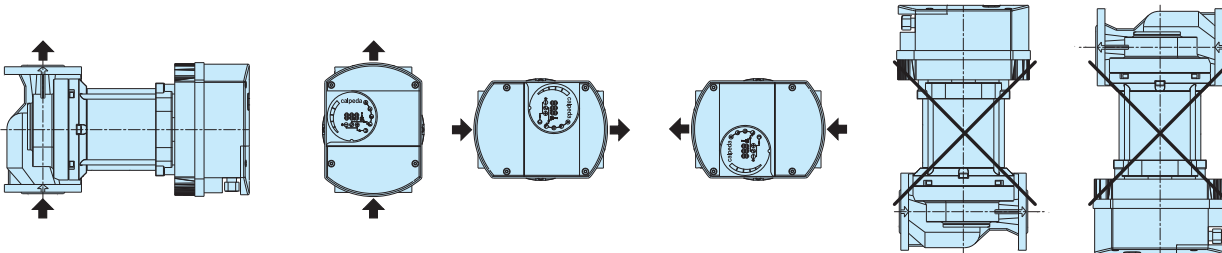

Dimensions and weights

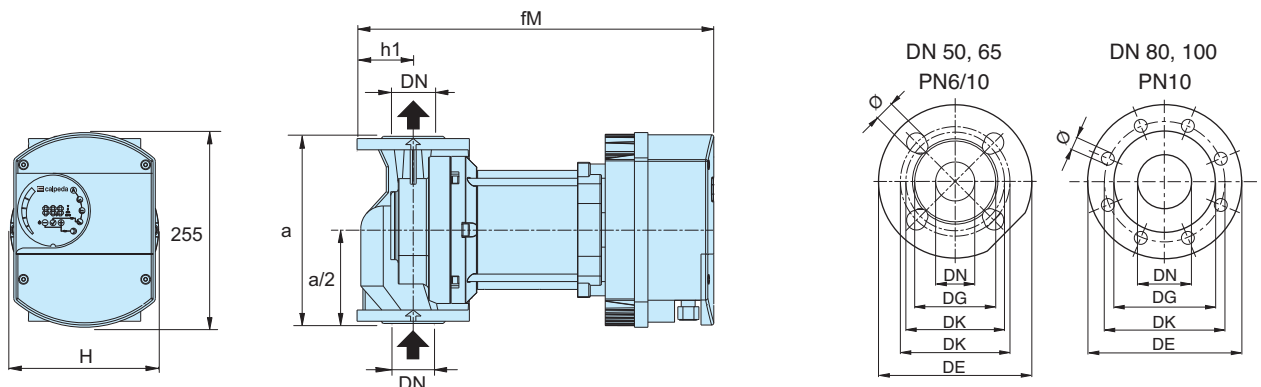

TYPE	DN	H m	Q m ³ /h	1~ 230 V A max	P ₁		mm				kg
					W min	W max	a	fM	h1	H	
NCE G 50F-180/280	50	17	40	8	10	1100	280	425	70	200	30
NCE G 65F-130/340	65	13	65	8	10	1100	340	449	80	222	36
NCE G 65F-180/340	65	17	60	8	10	1500	340	483	80	222	39
NCE G 80F-130/360	80	13	78	8	10	1600	360	503	100	230	44
NCE G 80F-180/360	80	17	62	8	10	1600	360	503	100	230	41
NCE G 100F-130/360	100	13	78	8	10	1600	360	513	110	230	47
NCE G 100F-180/360	100	17	62	8	10	1600	360	513	110	230	43

DN	DE	DK	DG	holes	
				N.	Ø
50	165	110/125	90	4	14/19
65	185	130/145	110	4	14/19
80	200	160	128	8	19
100	220	180	-	8	19